



think office

#02_partizioni_partitions

MOBILofficefurniture



#02_partizioni_partitions

MOBILofficefurniture

INDICE | CONTENT | SOMMAIRE

05	mobil office furniture - company profile mobil office furniture - company profile mobil office furniture - company profile
14	partizioni partitions cloison
16	parete monovetro P30 P30 single-pane wall cloison mono-vitre P30I
36	parete bivetrol P60 P60 double-pane wall cloison double vitrage P60
56	parete divisoria P100 P100 partition wall cloison de séparation P100
70	parete attrezzata P460 P460 wall unit cloison équipée P460
76	abaco degli elementi element abacus mélange des éléments
84	materiali e finiture materials and finishes matériaux et finitions



MOBILofficefurniture

Mobil Office Furniture, nata nel 1998, con uno stabilimento di 15.000 mq, fa parte della SCL&B Srl ed ha fatto del design e della funzionalità dell'arredo ufficio il proprio Core Business impostando la propria strategia di mercato nella ricerca continua di nuove soluzioni e finiture. Un'attenzione particolare è rivolta al rispetto per l'ambiente e all'ergonomia del posto di lavoro.

Mobil Office Furniture, born in 1998, with a factory of 15'000 mq, is part of SCL&B Srl. Its Core Business is made by design and functionality of office furniture, setting up their own market strategy, always searching new solution and finishes. A particular attention is directed towards the respect for the environment and the ergonomic of the work place.

Mobil Office Furniture, née en 1998, avec un établissement de 15'000 mq, est à partie du SCL&B Srl et a fait du design et du fonctionnalité des fournitures de bureau son Core Business en imposant sa stratégie commerciale dans la recherche de nouveaux solution et finition. Un attention particulière est adressée au respect pour l'environnement et au ergonomie du poste de travail.

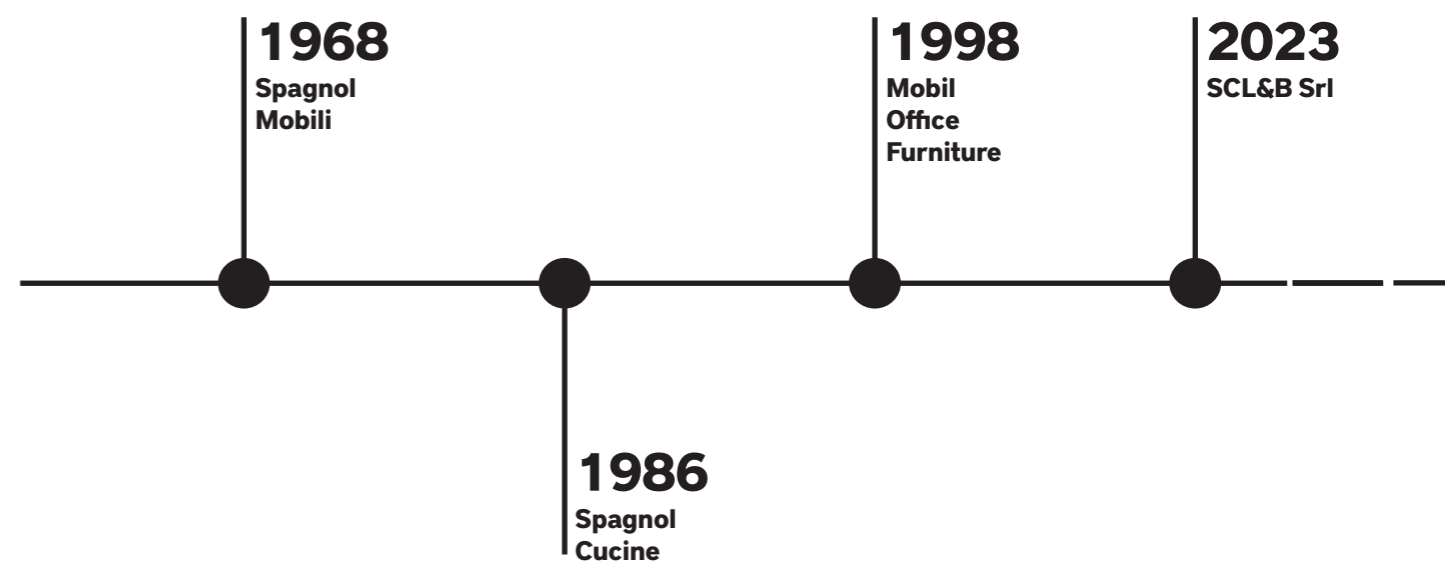

mission



Mobil Office Furniture è specializzata nella produzione di sistemi d'arredi sia uffici direzionali che operativi, produce e realizza sistemi di divisione degli spazi e fornisce progetti "chiavi in mano" sia ad enti privati che pubblici sia in Italia che all'estero. Le soluzioni d'arredo proposte sono orientate a migliorare la qualità dei luoghi di lavoro, con molta attenzione al rispetto dei regolamenti vigenti in termini di sicurezza e comfort. Le molteplici finiture e colori disponibili nelle varie collezioni permettono di rendere l'ambiente di lavoro piacevole e dinamico.

Mobil Office Furniture is specialized on the production of furnishing systems both directional and operational offices, produce and realize division space systems and provides "turn-key" projects to both private and public institutions in Italy and abroad. The furnishing solutions proposed are oriented to improve the quality of the work places, with lot of attention towards the respect for security regulations and comfort. The various finishing and colors available on the different collections allow the work place to be pleasant and dynamic.

Mobil Office Furniture est spécialisée dans la production de système de fournitures soit de bureau directionnelles que opérationnelles, il produit et réalise systèmes de séparation d'espace et donne des projet "clés en main" soit aux établissements privé que public, en Italie et à l'étranger. Les solutions des fournitures proposée sont orientée à améliorer la qualité du poste de travail, avec beaucoup d'attention au respect des réglementation de sécurité et de confort. les nombreuses finitions et couleurs disponibles dans les différents collections permettent de rendre le poste de travail plaisante et dynamique.

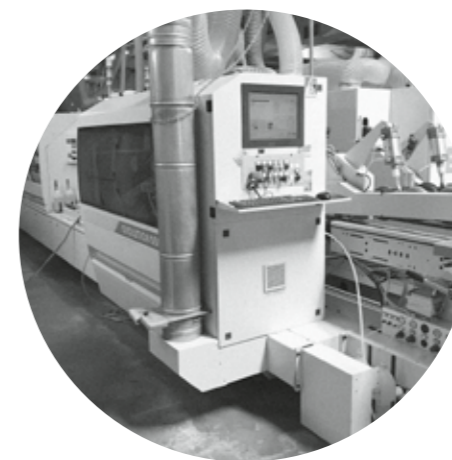

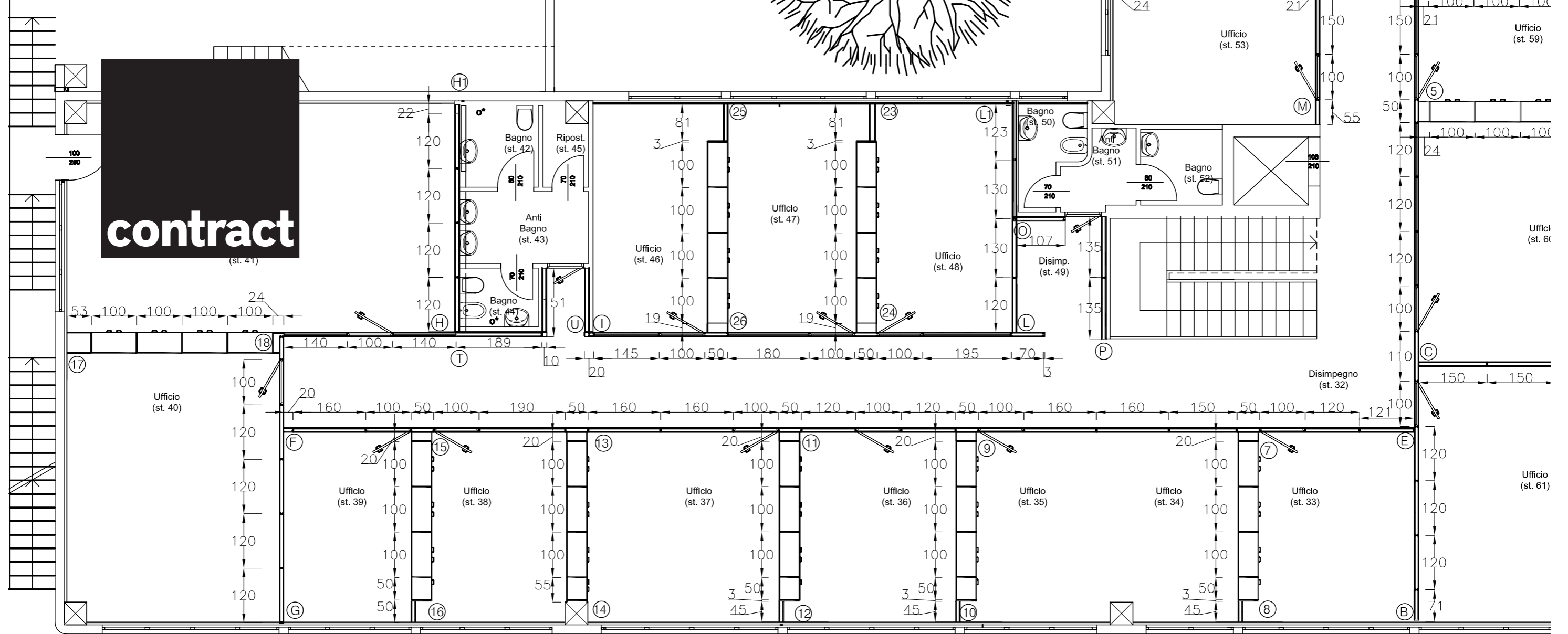

Forte di una lunga e collaudata esperienza nella produzione di arredi per la casa, da anni opera anche nel settore CONTRACT sia in Italia che all'estero con notevole esperienza tecnica nella progettazione, nella produzione e nella personalizzazione di arredi per uffici, aziende, hotel.

Strong of a long and tested experience on the production of furniture for the house, for years works even in the CONTRACT sector in Italy and abroad with remarkable technical experience in the design, production and personalization of furniture for offices, companies, hotels.

Fort d'une long et testée expérience dans la production des fournitures pour la maison, depuis des années il travail aussi dans le secteur CONTRACT soit en Italie que à l'étranger avec remarquable expérience technique dans le design, production et personnalisation des fournitures de bureau, entreprises, hôtels.

- Consulting
- Customer care
- Project
- Logistic
- Installation
- After sales support

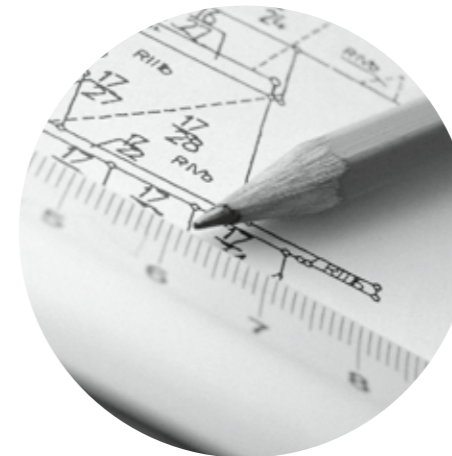

Customer support

Environment

10 **La nostra è una terra fortunata.
Ours is a very fortunate Region.
Notre région est une terre riche.**

La nostra è una terra fortunata. Qui sono nati celebri architetti e capaci artigiani, raffinati pittori e scultori, insigni musicisti e compositori. In ogni luogo c'è una bellezza creata dall'abilità e dal genio dei nostri Antenati. Nel 2019 le nostre Colline del Prosecco di Conegliano e Valdobbiadene sono state dichiarate Patrimonio dell'Umanità UNESCO. La ricerca del bello e dell'armonia è una nostra dote naturale.

Our is a very prosperous Region. Here many famous architects and skilled artisans, fine artists and sculptors were born. Everywhere you go, you can find the beauty created by the skill and genius of our ancestors. In 2019 the Prosecco Hills of Conegliano and Valdobbiadene were declared a UNESCO World Heritage Site. The search for beauty and harmony is our natural.

Notre région est une terre riche. Architectes célèbres et artisans capables, peintres et sculpteurs raffinés sont nés ici. Dans chaque endroit, il y a une beauté créée par l'habileté et le génie de nos ancêtres. En 2019, les collines du Prosecco de Conegliano et Valdobbiadene ont été déclarées site du patrimoine mondial de l'UNESCO. La recherche de la beauté et de l'harmonie est une qualité naturelle pour nous.



100% Made in Italy



**Concept- Design- Made 100% in Italy
Ogni prodotto è progettato, concepito e
realizzato totalmente in Italia per assicurare
un elevato standard qualitativo.**

Design and concept 100% made in Italy

Every product is designed and realized completely in Italy to ensure a high quality standard, with a unique technological know-how, pursuing a handcrafted ability combined with highly flexible and adaptable structures.

Design et concept 100% made in Italy

Chaque produit est projeté, conçu et réalisée totalement en Italie pour assurer un élevé standard qualitatif, avec un know-how technologique unique, en poursuivant une capacité artisanale combinée aux équipements hautement flexibles et polyvalentes.

**Standard qualitativi d'eccellenza.
Aderire ai più alti standard qualitativi
internazionali, garantisce prodotti progettati
secondo i migliori criteri di funzionalità,
ergonomia e design, consegne sicure e
rapide e montaggi efficienti.**

Excellence quality standard

Joining the highest International quality standard shall ensure products designed by the best functionality, ergonomics parameters; safe and fast deliveries and efficient assembly.

Standard qualitatifs d'excellence

Adhérer au plus élevés standard qualitatifs internationaux, assure produits conçus selon les meilleurs critères de fonctionnalité, ergonomie et design, livraison sûres et rapides et assemblages efficientes.

Ecologia e ambiente

Cosa significa eco-sostenibile? Sentiamo spesso parlare di eco-sostenibilità, ma in molti, hanno un'idea ancora molto vaga di cosa significa eco-sostenibile nello specifico. Eco-sostenibile o eco-friendly, consiste in una serie di comportamenti compatibili con l'ambiente circostante in quanto non ne usurpano le risorse. Chi sceglie di aiutare l'ambiente e quindi di essere eco-sostenibile, grazie ad una serie di piccole azioni giornaliere come ad esempio, ridurre gli sprechi, riciclare e riutilizzare, si contribuisce alla salvaguardia del pianeta riducendo l'accumularsi rifiuti nell'indifferenziato.

What does environmentally sustainable mean? We often hear talks about environmentally sustainable, but lots of people still do not have a clear idea about what environmentally sustainable means. Environmentally sustainable or eco-friendly, consist of a series of behaviors compatibles with the surrounding environment since they shall not encroach the resources. People who choose to help the environment and so to be environmentally sustainable, thank to a series of little daily actions like, cut down on waste, recycling and reuse, contributes to protection of the Earth reducing accumulation of mixed waste.

Qu'est-ce que cela signifie écologique? Nous entendons souvent parler d'écologique, mais dans de nombreux, ont un' idée vague de ce qu'est écologique. Écologique ou eco-friendly, consiste en une série de comportement compatibles avec l'environnement en tant que n'empiètent pas les ressources. Qui choisit d'aider l'environnement et ensuite d'être écologique, grâce à une série de petites actions journalières comme par exemple, réduire les gaspillages, recycler et réutiliser, on contribue à la sauvegarde de la Terre en réduisant l'accumuler des déchets mixtes.



ISO 9001
ISO 14001





partizioni

Dividere lo spazio per razionalizzare e facilitare il lavoro. La ricerca e il desiderio di innovazione hanno portato Mobil Office Furniture a creare un sistema di proposte capaci di soddisfare ogni esigenza progettuale ed estetica. Identificare, distribuire, aggiornare lo spazio secondo l'evoluzione del lavoro singolo o di gruppo personalizzando le mansioni, favorire la comunicazione o la privacy. Le partizioni garantiscono soluzioni di arredo avanzate e facili "da abitare".

Divide the space to make your working life easier. Research and a desire for innovation have led Mobil Office Furniture to create a series of furnishing solutions to suit every aesthetic and design style. Characterise, arrange and update your space to suit the evolving requirements of individual workers or teams, to allow for personalised workflows and favour either communication, or privacy. Partitions give you advanced, easy-living furnishing solutions.

Diviser l'espace pour rationaliser et faciliter le travail. La recherche et le désir d'innovation ont conduit Mobil Office Furniture à créer un système de propositions capables de répondre à tous les besoins de conception et d'esthétique. Identifier, distribuer, mettre à jour l'espace en fonction de l'évolution du travail individuel ou de groupe en personnalisant les tâches et favoriser la communication ou la vie privée. Les partitions garantissent des solutions d'ameublement avancées et faciles à «vivre».

- parete monovetro P30
- parete bivetrotto P60
- parete divisoria P100
- parete attrezzata P460

monovetro P30

La ricerca di innovazione ha portato a creare un sistema di partizioni con spessore 30 mm costituite da lastre monovetro temperato spessore 10 mm /12mm o in stratificato 5+5mm o 6+6mm con foglio interno PVB da 0,38mm. Sono previste anche pannellature cieche spessore 22mm in classe E1 a bassa emissione di formaldeide. Uno spintore permette un'escursione terra/soffitto di +/- 20mm. I montanti ed i profili in alluminio sono ridotti al minimo per creare continuità nei frontali.

Our search for innovation has led to the creation of a new system of partitions with a thickness of 30 mm, made from 10 mm / 12 mm single-pane tempered glass sheets, 5+5 mm laminate or 6+6mm panes with an internal PVB layer (0.38 mm). Blind panels are also available, with a 22mm thickness in class E1 (low formaldehyde emissions). The pusher bar allows overfloor/overhead travel of +/- 20mm. The aluminium uprights and profiles are minimised, to create continuity on the front panels.

La recherche d'innovation a conduit à la création d'un système de cloisons d'une épaisseur de 30 mm, constituées de plaques mono-vitre trempé d'une épaisseur de 10 mm/12 mm ou en stratifié 5+5 mm ou 6+6 mm avec feuille intérieure PVB de 0,38 mm. Des panneaux aveugles d'une épaisseur de 22 mm, en classe E1 à faible émission de formaldéhyde, sont également prévus. Un poussoir permet une excursion sol/plafond de +/- 20 mm. Les montants et les profilés en aluminium sont réduits au minimum pour créer une continuité dans les façades.

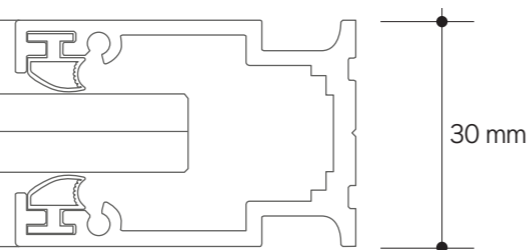

metallo | metal | metal

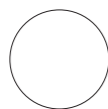

bianco
white
blanc



antracite
anthracite
anthracite

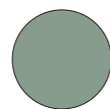

kaffir
kaffir
kaffir



indigo
indigo
indigo

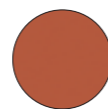

paprika
paprika
paprika



curry
curry
curry







Angoli e nodi. I moduli vetrati o ciechi vengono uniti tra loro da giunti trasparenti in policarbonato per avere una perfetta coplanarità e stabilità delle lastre e dei pannelli.

Corners and hubs. The glazed or blind panels are attached by transparent polycarbonate joints to ensure perfect coplanarity and stability of the plates and panels.

Angles et nœuds. Les modules vitrés ou aveugles sont reliés entre eux par des joints transparents en polycarbonate, pour avoir une parfaite coplanarité et stabilité des plaques et des panneaux.





Equilibrio tra privacy e condivisione. La porta battente pannellata montata su 2 cerniere dispone di maniglia in alluminio con serratura integrata. L'ingombro minimo degli stipiti segue i canoni della parete leggera ed essenziale.

Privacy and communication: the perfect balance. The solid panelled door, mounted on 2 hinges, has an aluminium handle with integrated lock. The jamb size is minimal, in line with the light and minimalist style.

Équilibre entre la vie privée et le partage. La porte battante lambrissée montée sur 2 charnières dispose d'une poignée en aluminium avec serrure intégrée. L'encombrement minimum des montants suit les canons de la paroi légère et essentielle.

25



monovetro P30

MOBILofficefurniture





Trasparenza e privacy. L'utilizzo di pellicole adesive concorre a personalizzare ogni tipo di esigenza operativa permettendo il vedere non vedere in un gradevole gioco di luci ed ombre.

Transparency and privacy. The use of adhesive film is a great way to customise the workspace, revealing or obscuring in an attractive play of light and shadows.

Transparence et vie privée. L'utilisation de films adhésifs contribue à personnaliser chaque type d'une nécessité opérationnelle, permettant de voir dans un agréable jeu de lumières et d'ombres.









Tecnica e cura del particolare. Delicate trasparenze, montanti verticali ridotti al minimo sono segni ove ogni elemento è ridotto alla sua essenza e il sapiente inserimento del colore è un ulteriore elemento caratterizzante e personale.

Technique and attention to detail. The fine transparencies and slender uprights are hallmarks of this design, in which each element is reduced to its essence. The skilful use of colour is another characteristic and highly personal feature.

Technique et soin du détail. Transparences délicates, les montants verticaux réduits au minimum sont des signes où chaque élément est réduit à son essence et l'insertion judicieuse de la couleur est un autre élément caractéristique et personnel.

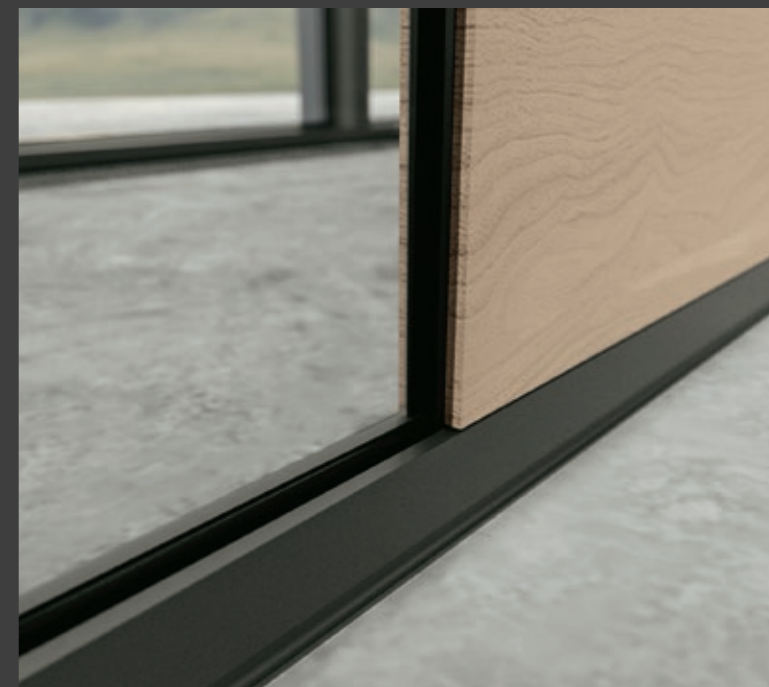
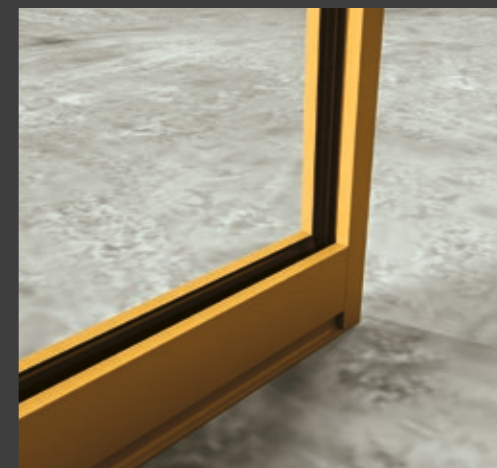
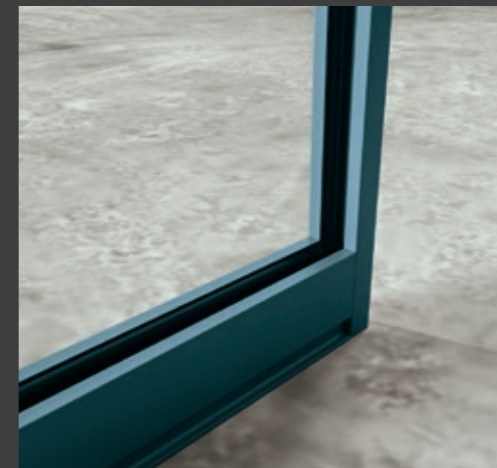
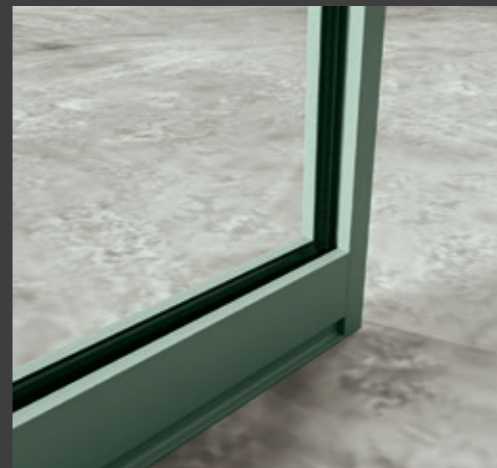

bivetro P60

36

Adattabilità progettuale alle esigenze dello spazio e di chi vi lavora sono le basi del progetto bivetro di spessore 60mm, costituito da doppia lastra in vetro temperato spessore 10mm/12mm o in vetro stratificato 5+5mm o 6+6mm con foglio interno PVB da 0,38mm. Sono previste anche doppie pannellature cieche spessore 22 mm in classe E1 a bassa emissione di formaldeide. Uno spintore permette un'escursione terra/soffitto di +/-20mm. I montanti ed i profili in alluminio sono ridotti al minimo per creare continuità nei frontali.

The ability to adapt to the needs of the space and the workers is the basis for the 60mm dual-pane design, consisting of a double plate of tempered glass (10mm/12mm), 5+5mm laminated glass, or 6+6mm laminated glass with an internal PVB layer (0.38 mm). There are also 22 mm double blind panels in class E1, with low formaldehyde emissions. The pusher bar allows an overfloor/overhead travel of +/-20mm. The aluminium uprights and profiles are minimised, to create continuity on the front panels.

L'adaptabilité de la conception aux besoins de l'espace et de ceux qui y travaillent sont les bases du projet Bivetro d'une épaisseur de 60 mm, constitué d'une double plaque de verre trempé de 10 mm/12 mm d'épaisseur ou en verre feuilleté 5+5 mm ou 6+6 mm avec feuille intérieure PVB de 0,38 mm. Des doubles panneaux aveugles d'une épaisseur de 22 mm sont également prévus dans la classe E1 à faible émission de formaldéhyde. Un poussoir permet une excursion sol/plafond de +/- 20 mm. Les montants et les profilés en aluminium sont réduits au minimum pour créer une continuité dans les façades.

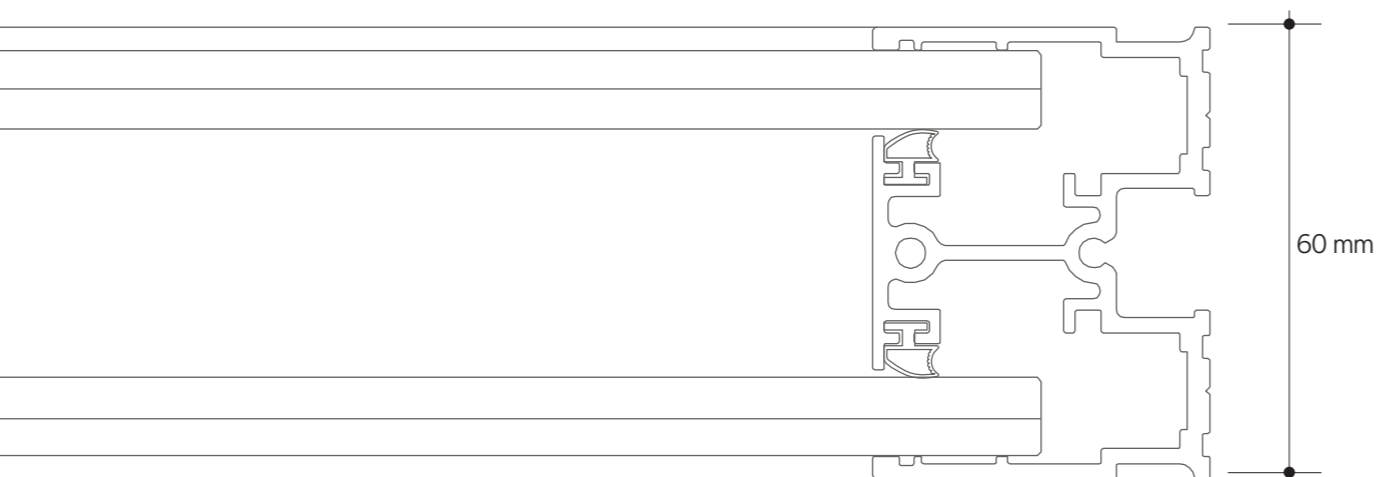

metallo | metal | metal

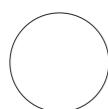

bianco
white
blanc



antracite
anthracite
anthracite

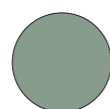

kaffir
kaffir
kaffir



indigo
indigo
indigo

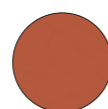

paprika
paprika
paprika



curry
curry
curry

37



bivetro P60

MOBILofficefurniture





**La cura del particolare scopre la funzionalità.
Il modulo tecnico cavo in profilo di alluminio
risponde puntualmente alle necessità di
elettrificazione in ufficio e si interfaccia con
ogni componente del sistema.**

Attention to detail reveals functionality. The cabling module with aluminium profile is a great solution to office electrification needs, and coordinates with each component of the system.

Le soin du détail découvre la fonctionnalité. Le module technique creux en profilé d'aluminium répond ponctuellement aux besoins d'électrification dans le bureau et s'interface avec chaque composant du système.







Il vetro, non solo materiale, ma elemento da personalizzare. La trasparenza del vetro può diventare elemento decorativo inserendo adesivi e serigrafie o elemento di comunicazione inserendo messaggi, foto, disegni. Liberi di personalizzare il proprio spazio.

Glass is more than just a material, it's a feature you can customise. The transparency of the glass becomes a decorative element, with stickers, serigraphs or communicative elements such as slogans, photos and drawings. Make your space your own.

45

Le verre, non seulement matériau, mais aussi élément à personnaliser. La transparence du verre peut devenir un élément décoratif en insérant des autocollants et des sérigraphies ou un élément de communication en insérant des messages, des photos et des dessins. Libre à vous de personnaliser votre espace.



bivetro P60

MOBILofficefurniture



**Nodi e connessioni senza limiti di componibilità.
Un sistema completo di elementi accessori per unire
una parte all'altra. Raccordi a 90°, lineari, a 3 o 4 vie
per comporre senza limiti di spazio.**

Hubs and connections with no limits. A complete system of accessories to join one section to the next. 90°, linear, 3- or 4-way fittings so you can compose your design with no limits on space.

Des nœuds et connexions sans limites de composabilité. Un système complet d'éléments accessoires pour unir une partie à l'autre. Des raccords à 90°, linéaires, à 3 ou 4 voies pour composer sans limites d'espace.



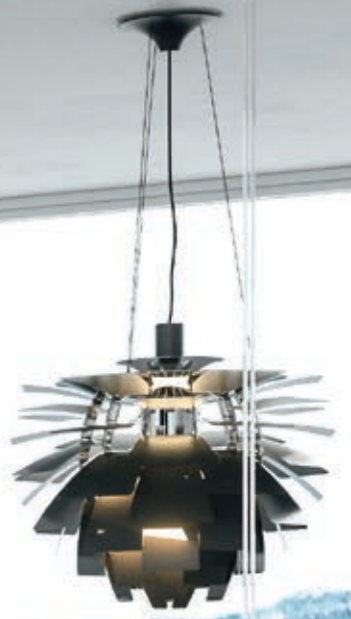
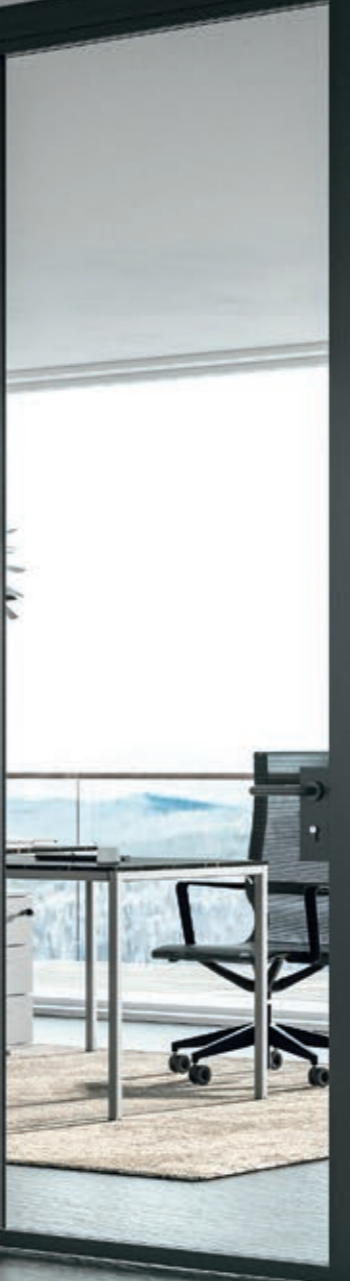

bivetro P60



Integrazione tra casa e ufficio in un arredo univoco. Una struttura modulare perfetta che dialoga con gli elementi della parete e si riflette allargando lo spazio all'infinito. Un ambiente dal sapore domestico nel contesto lavorativo attuale, iperconnesso e smart.

Integrate home and office with a seamless design. A perfectly modular structure that communicates with the partition elements and expands the space to infinity. Bring that sense of home into the modern, hyper-connected and smart workplace.

Une intégration entre la maison et le bureau dans un mobilier univoque. Une structure modulaire parfaite qui dialogue avec les éléments de la cloison et se reflète en élargissant l'espace à l'infini. Un environnement à la maison dans le contexte professionnel actuel, hyperconnecté et intelligent





54

Da una stanza all'altra spazi aperti, luci, ombre, trasparenze. Il gioco degli accostamenti esalta le geometrie essenziali dell'ambiente e della parete, che cresce all'infinito. L'ufficio esprime la libertà di vivere lo spazio personale seguendo il momento. Dall'insieme al particolare, lo stesso progetto.

55

Open-space layouts, lights, shadows and transparencies lead from one room to the next. Carefully coordinated combinations enhance the geometries of the setting and the wall, which expands into infinity. An office that expresses your freedom to enjoy personal space depending on the needs of the moment. The design is fully coherent, from the overall look to the smallest detail.

D'une pièce à l'autre, des espaces ouverts, des lumières, des ombres et des transparences. Le jeu des combinaisons exalte les géométries essentielles de l'environnement et de la cloison, qui croît à l'infini. Le bureau exprime la liberté de vivre l'espace personnel en suivant le moment. De l'ensemble au détail, le même projet.

bivetro P60



MOBILofficefurniture



Maniglie, serrature, pensili, contenitori a parete concorrono tutti alla perfetta conformità di ciascun componente ad ogni tipo di esigenza funzionale con un'attenzione sempre rivolta alla cura estetica del dettaglio.

The handles, locks, cabinets and wall-mounted units all contribute to the seamless cohesion of compo-

nents that cater for every functional requirement. The focus is always on the aesthetics of the details.

Poignées, serrures, armoires, conteneurs à parois concourent tous à la parfaite conformité de chaque composant à tout type d'exigence fonctionnelle avec une attention toujours portée au soin esthétique du détail.



divisoria P100

Dividere lo spazio per razionalizzare l'operatività. La parete divisoria "classica" con i profili importanti da 100mm ha tre modalità di rivestimento bifacciale: vetro a filo esterno, cieco o cieco-vetro. Il vetro è stratificato 3+3mm con foglio interno PVB da 0,38mm. La doppia pannellatura cieca è in melaminico classe E1 spessore 18mm, a bassa emissione di formaldeide. Uno spintore permette una regolazione terra/soffitto di +/- 30mm. Una gamma di soluzioni capace di soddisfare ogni esigenza progettuale più tradizionale nel pieno rispetto del singolo.

Divide the space to make your working life easier. The "classic" partition wall with the large 100mm profiles has three types of dual-sided finish: flush-mounted glass, blind or blind-glass. The glass is 3+3 mm laminate, with an internal PVB layer (0.38 mm). The 18 mm blind double panneling is made from melamine, class E1, with low formaldehyde emissions. The pusher bar allows overfloor/overhead travel of +/- 30mm. A range of solutions that responds to the need for traditional design, while fully respecting the individual.

Diviser l'espace pour rationaliser le fonctionnement. La cloison de séparation « classique » avec les profilés importants de 100 mm, dispose de trois modes de revêtement double face: verre à bord extérieur, aveugle ou aveugle-verre. Le verre est stratifié 3+3 mm avec feuille intérieure PVB de 0,38 mm. Le double panneau aveugle est en mélaminé de classe E1 d'une épaisseur de 18 mm, à faible émission de formaldéhyde. Un pousseur permet un réglage sol/plafond de +/- 30 mm. Une gamme de solutions capable de répondre à tous les besoins de conception les plus traditionnels dans le respect total du simple.

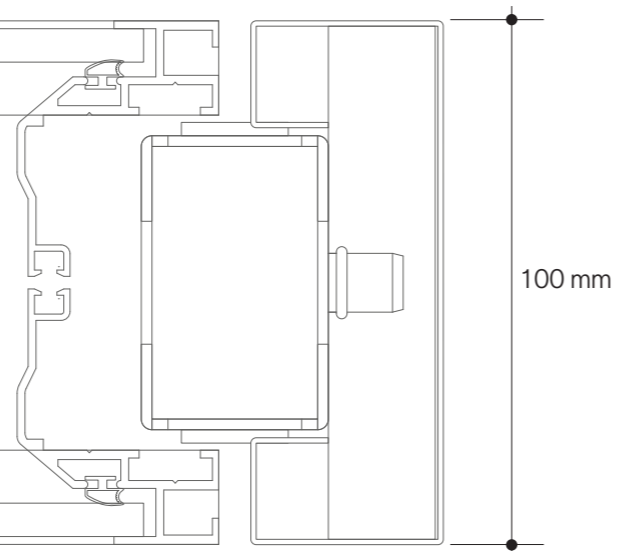

metallo | metal | metal

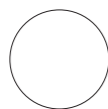

bianco
white
blanc



antracite
anthracite
anthracite

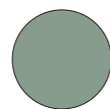

kaffir
kaffir
kaffir



indigo
indigo
indigo

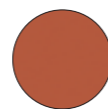

paprika
paprika
paprika



curry
curry
curry





Nuove prospettive per un originale gioco di pieni vuoti. La varietà degli accessori permette di attrezzare e personalizzare il posto lavoro alle esigenze di ogni singolo operatore.

New perspectives for an original effect of full and empty spaces. The variety of accessories allows you to customise and design your workplace to suit the needs of each individual operator.

De nouvelles perspectives pour un jeu original de leins vides. La variété des accessoires permet d'équiper et de personnaliser le lieu de travail aux besoins de chaque opérateur.





Il sistema "boiserie" con elementi pensili.
La solidità della parete consente di attrezzare
uno o entrambi i frontali della parete con
moduli di contenimento e mensole,
agganciati alla struttura portante.

Boiserie system with wall-mounted elements.
 The wall is solid enough to allow fitting of one or both
 front panels with shelves and cabinets, which are
 attached to the load-bearing structure.

Le système « boiserie » avec des éléments suspendus.
 La solidité de la cloison permet d'équiper une ou les deux
 faces de la paroi de modules de confinement et
 d'étagères, accrochés à la structure porteuse







Il sistema di pareti divisorie ordina l'ambiente di lavoro aprendo una serie di optionals tesi a risolvere svariate problematiche del lavoro odierno. La fonoassorbenza viene risolta da un sistema di tamponamento testato per migliorare il comfort acustico ed eliminare i riverberi.

The system of partitions defines the workspace, opening up a series of optional features designed to solve the problems of the modern workplace. Acoustics are resolved with an absorption system specially tested to improve comfort and eliminate sound reverberations.

Le système de cloisons ordonne l'environnement de travail, en ouvrant une série d'options visant à résoudre divers problèmes du travail d'aujourd'hui. La phono-absorption est résolue par un système de tamponnement testé pour améliorer le confort acoustique et éliminer les réverbérations.



La cura del particolare a testimonianza della tradizione artigianale. La parete non è solo un elemento di separazione degli spazi, ma la soluzione efficiente ad ogni necessità.

The attention to detail typifies the craftsmanship of this product. The partition is more than just a separation of spaces: it's an efficient solution to every need.

Le soin du détail comme témoignage de la tradition artisanale. La cloison n'est pas seulement un élément de séparation des espaces, mais la solution efficace à chaque besoin.

74



75

divisoria P100

MOBILofficefurniture



attrezzata P430

76

La parete attrezzata a tutta altezza è costituita da una struttura in melaminico da 22mm con schienali e ante da 18mm in classe E1 a bassa emissione di formaldeide. Lo spessore totale della parete è di 460mm; la modularità degli elementi è di 500 mm e 1000mm. I piedini regolabili permettono una escursione di +/-30mm. Gli zoccoli inferiori e superiori hanno uno spessore di 45mm.

The full-height partition has a 22mm melamine structure with backrests and an 18 mm door, class E1 with low formaldehyde emissions. Total thickness of the wall is 460 mm; the modularity of the elements is 500 mm and 1000 mm. Adjustable feet allow travel of +/-30mm. The upper and lower mouldings have a thickness of 45 mm.

La cloison entièrement équipée se compose d'une structure en mélaminé de 22 mm avec dossiers et portes de 18 mm de classe E1, à faible émission de formaldéhyde. L'épaisseur totale de la cloison est de 460 mm ; la modularité des éléments est de 500 mm et 1 000 mm. Les pieds réglables permettent une excursion de +/- 30 mm. Les sabots inférieurs et supérieurs ont une épaisseur de 45 mm.

metallo | metal | metal

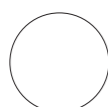

bianco
white
blanc



antracite
anthracite
anthracite



kaffir
kaffir
kaffir



indigo
indigo
indigo

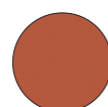

paprika
paprika
paprika



curry
curry
curry



77

attrezzata P430

MOBILofficefurniture



Per risolvere ogni tipo di contenimento e archiviazione la parete attrezzata si integra con le tre serie divisorie. Ripiani mobili, schedari fissi ed estraibili, portaschede, una gamma completa e funzionale di accessori all'insegna del recupero dello spazio, della personalizzazione e della facilità di accesso alla documentazione.

To resolve all your storage and archiving needs, the wall unit is fully integrated into the three partition series. Mobile shelves, fixed and removable ledgers, document holders: a complete and functional range of accessories designed to save space, offer customisation options and allow easy access to documentation.

Pour résoudre tout type de confinement et de stockage, la cloison équipée s'intègre aux trois séries de cloisons. Étagères mobiles, classeurs fixes et amovibles, porte-cartes, une gamme complète et fonctionnelle d'accessoires sous le signe de la récupération de l'espace, de la personnalisation et de la facilité d'accès à la documentation.





abaco

Abaco degli elementi Element abacus | Mélange des éléments

parete monovetro P 30mm

H2 (mm. 2146 ÷ 2409)

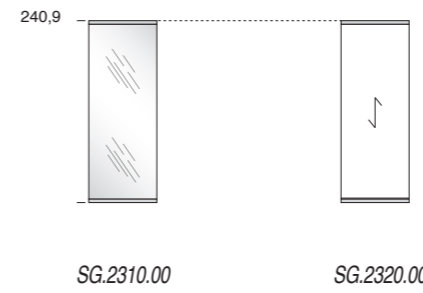

H3 (mm. 2410 ÷ 2809)

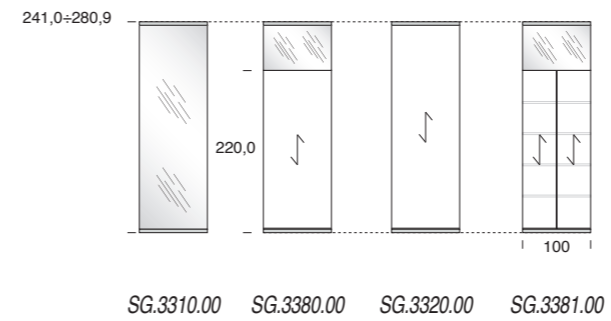

H4 (mm. 2810 ÷ 3000)

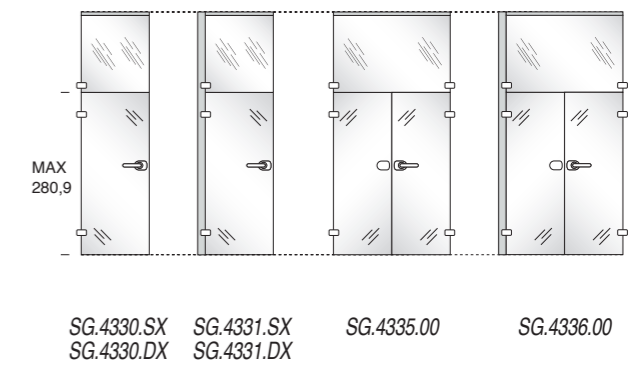
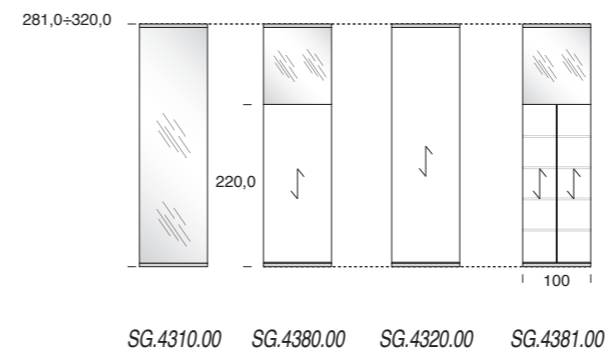

metallo | metal | metal



bianco
white
blanc



antracite
anthracite
anthracite



kaffir
kaffir
kaffir



indigo
indigo
indigo



paprika
paprika
paprika



curry
curry
curry

parete monovetro P 30mm

H2 (mm. 2146 ÷ 2409)

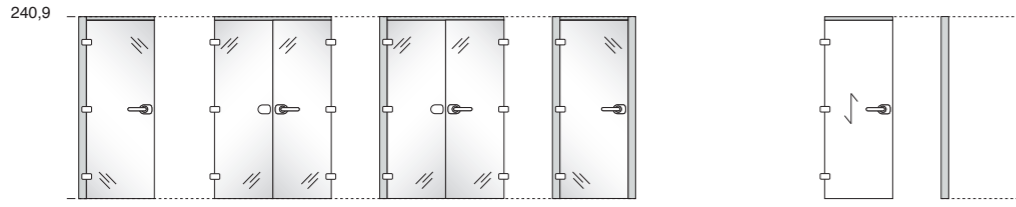

SG.2361.DX
SG.2361.SX

SG.2365.00

SG.2366.00

SG.2384.DX
SG.2384.SX

SG.2380.DX
SG.2380.SX

SG.MT20.00

86

parete monovetro P 30mm

H2 (mm. 2146 ÷ 2409)

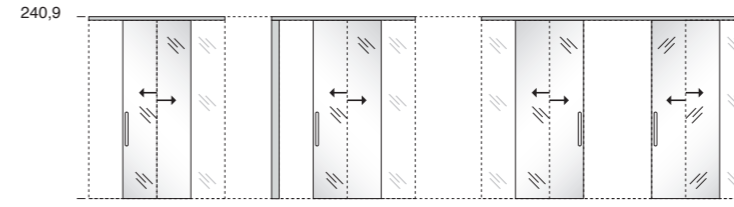

SG.2370.SX
SG.2370.DX

SG.2372.SX
SG.2372.DX

SG.2375.00
SG.2376.00*
*(serr. / lock)

SG.2371.SX*
SG.2371.DX*
*(serr. / lock)

SG.2373.SX*
SG.2373.DX*
*(serr. / lock)

87

H3 (mm. 2410 ÷ 2809)

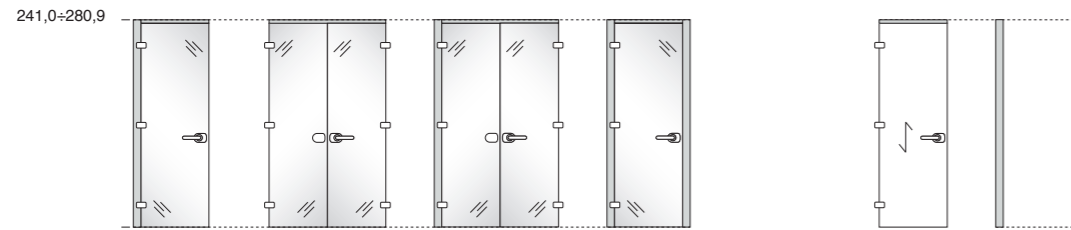

SG.3361.DX
SG.3361.SX

SG.3365.00

SG.3366.00

SG.3384.DX
SG.3384.SX

SG.3380.DX
SG.3380.SX

SG.MT30.00

H3 (mm. 2410 ÷ 2809)

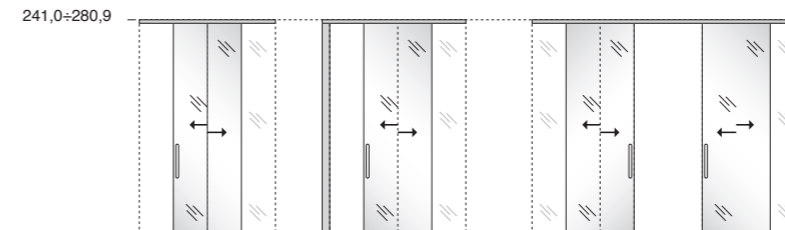

SG.3370.SX
SG.3370.DX

SG.3372.SX
SG.3372.DX

SG.3375.00
SG.3376.00*
*(serr. / lock)

SG.3371.SX*
SG.3371.DX*
*(serr. / lock)

SG.3373.SX*
SG.3373.DX*
*(serr. / lock)

abaco

H4 (mm. 2810 ÷ 3000)



SG.4385.SX
SG.4385.DX

SG.4381.SX
SG.4381.DX

SG.4382.DX
SG.4382.SX

SG.MT40.00

H4 (mm. 2810 ÷ 3000)

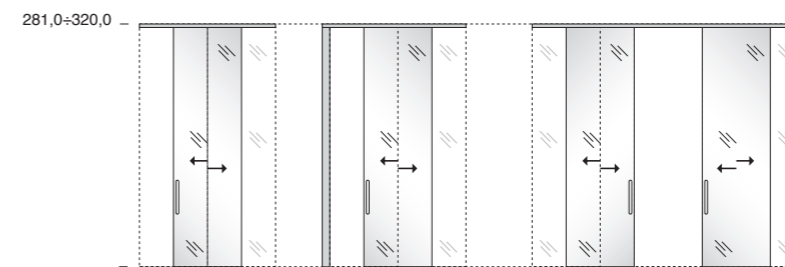

SG.4370.SX
SG.4370.DX

SG.4372.SX
SG.4372.DX

SG.4375.00
SG.4376.00*
*(serr. / lock)

SG.4371.SX*
SG.4371.DX*
*(serr. / lock)

SG.4373.SX*
SG.4373.DX*
*(serr. / lock)

MOBILofficefurniture

parete bivetto P 60mm

H2 (mm. 2146 ÷ 2409)

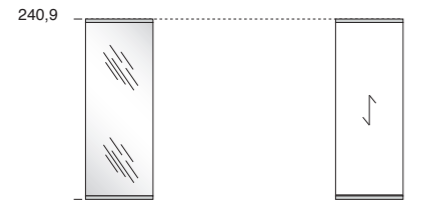

SG.2310.00

SG.2320.00

88

parete bivetto P 60mm

H2 (mm. 2146 ÷ 2409)

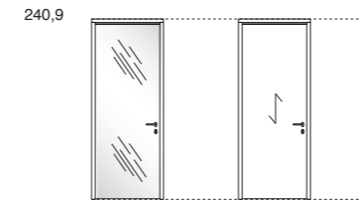

SG.2361.DX
SG.2361.SX

SG.2380.DX
SG.2380.SX

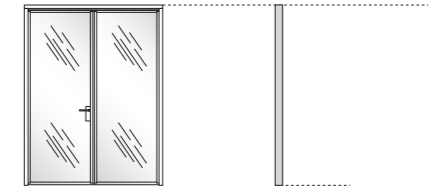

SG.2365.00

SG.MT20.00

89

H3 (mm. 2410 ÷ 2809)

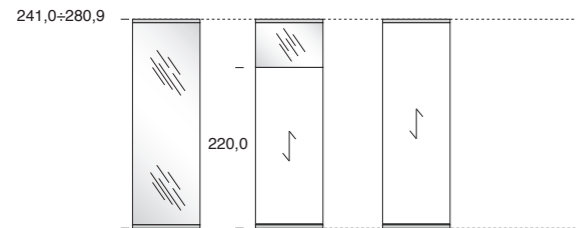

SG.3310.00

SG.3380.00

SG.3320.00

H3 (mm. 2410 ÷ 2809)

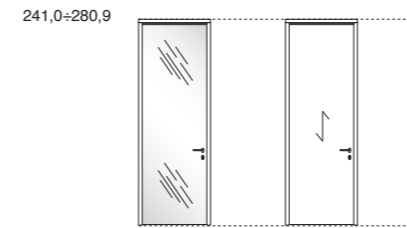

SG.3361.DX
SG.3361.SX

SG.3380.DX
SG.3380.SX

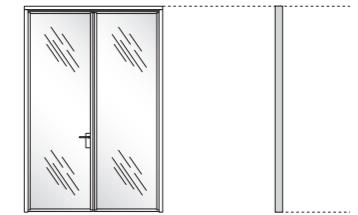

SG.3365.00

SG.MT30.00

abaco

H4 (mm. 2810 ÷ 3000)

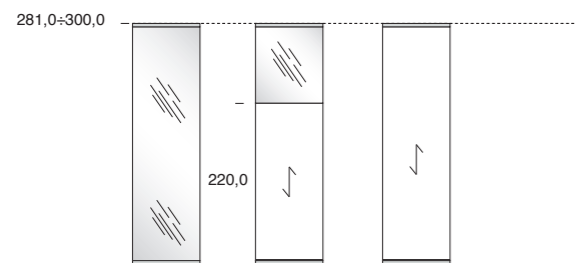

SG.4310.00

SG.4380.00

SG.4320.00

H4 (mm. 2810 ÷ 3000)

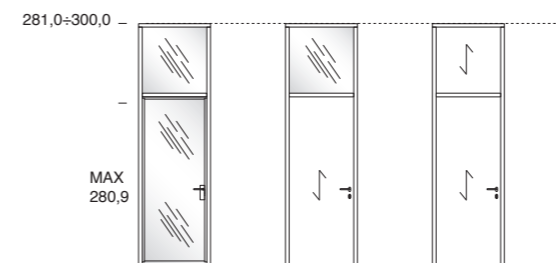

SG.4385.SX
SG.4385.DX

SG.4381.SX
SG.4381.DX

SG.4382.DX
SG.4382.SX

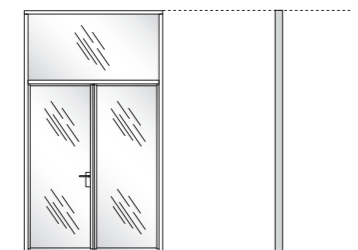

SG.4335.00

SG.MT40.00

MOBILofficefurniture

parete bivetto P 60mm

H2 (mm. 2146 ÷ 2409)

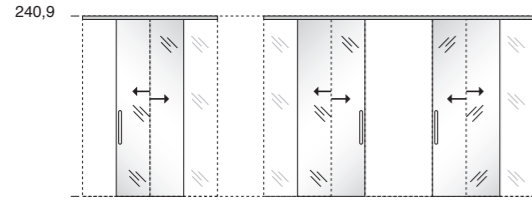

SG.2370.SX
SG.2370.DX

SG.2371.SX*
SG.2371.DX*
*(serr. / lock)

SG.2375.00
SG.2376.00*
*(serr. / lock)

H3 (mm. 2410 ÷ 2809)

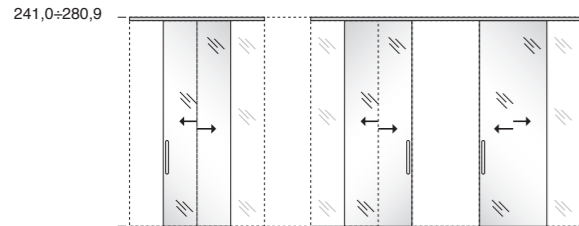

SG.3370.SX
SG.3370.DX

SG.3371.SX*
SG.3371.DX*
*(serr. / lock)

SG.3375.00
SG.3376.00*
*(serr. / lock)

H4 (mm. 2810 ÷ 3000)

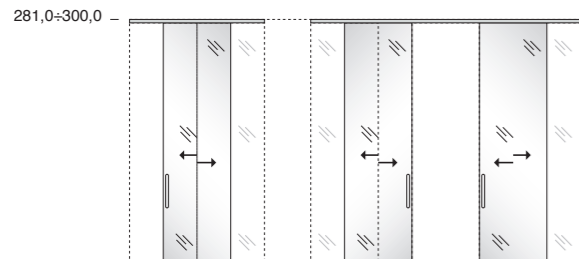

SG.4370.SX
SG.4370.DX

SG.4371.SX*
SG.4371.DX*
*(serr. / lock)

SG.4375.00
SG.4376.00*
*(serr. / lock)

parete divisoria P 100mm

H2 (mm. 2360 ÷ 2700)

PORTE
DOORS **H. 2172**

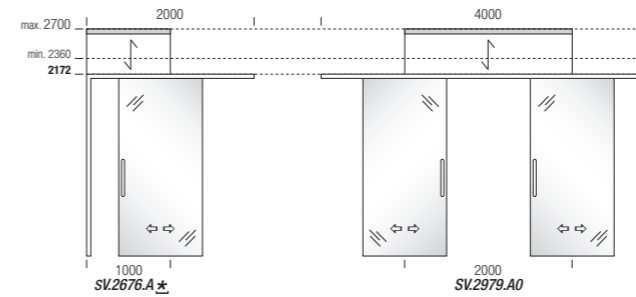
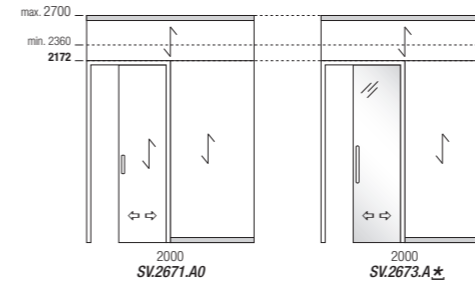
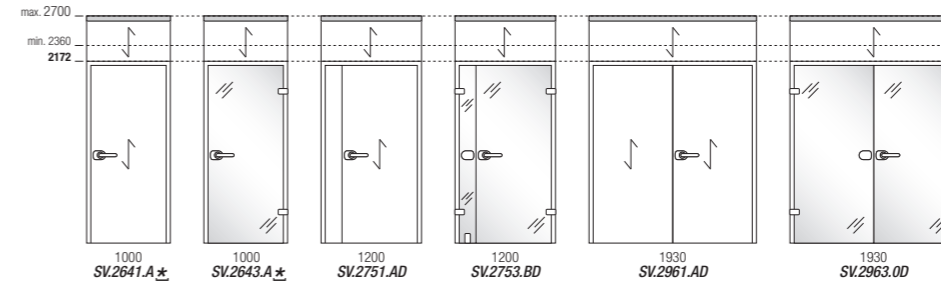
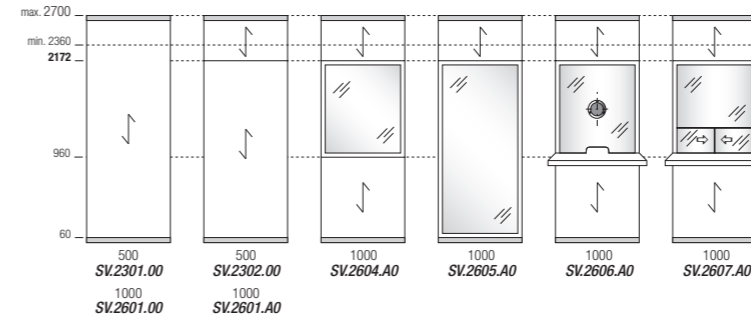

* SPECIFICARE: D = DESTRO - S = SINISTRO / SPECIFY: D=RIGHT - S=LEFT

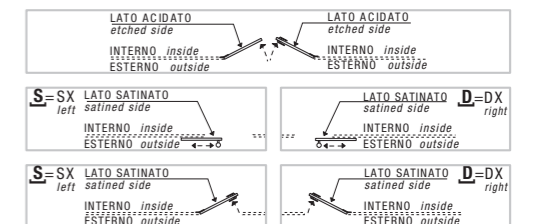

parete divisoria P 100mm

H3 (mm. 2701 ÷ 3096)

PORTE
DOORS **H. 2172 A**

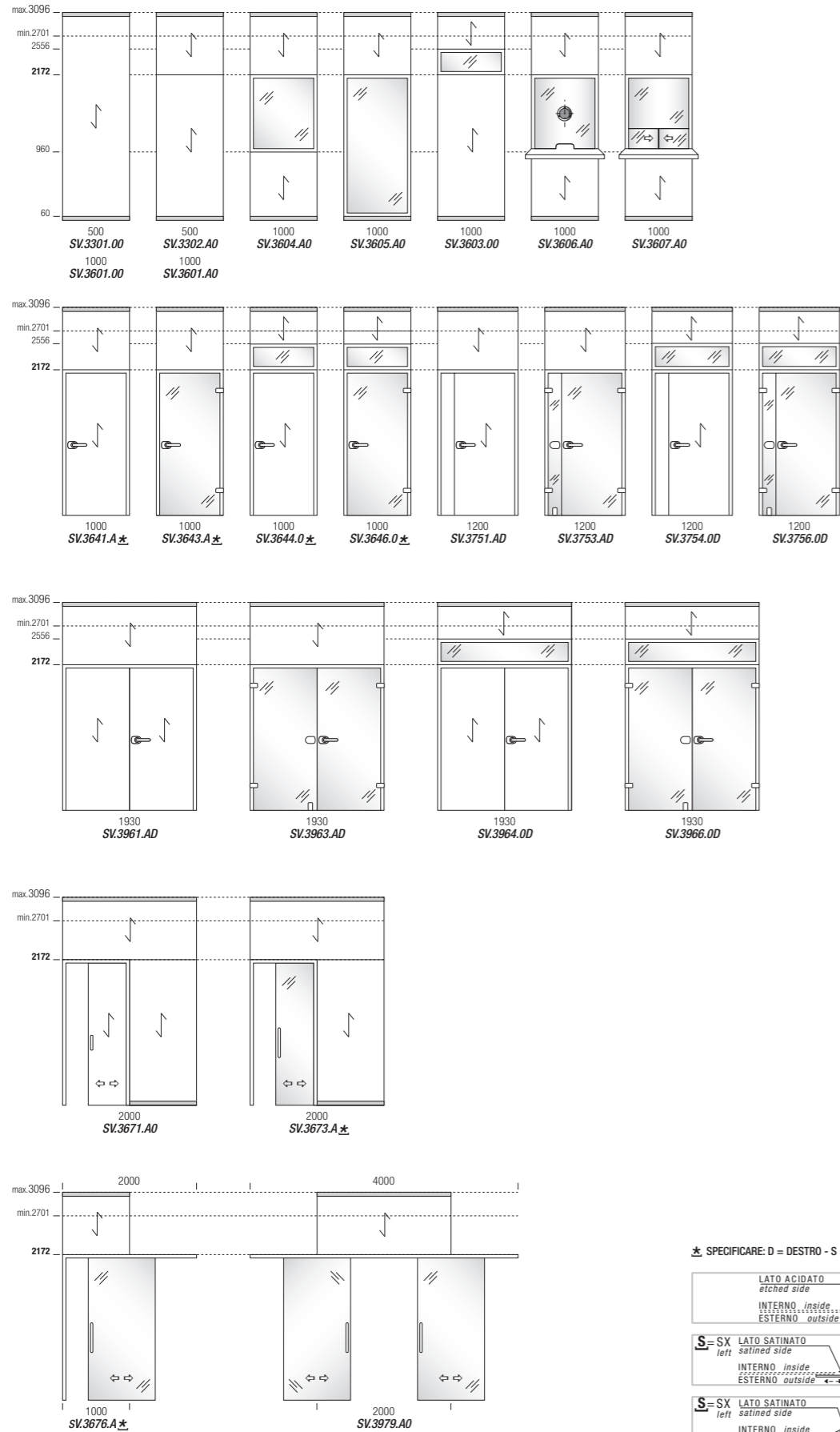

± SPECIFICARE: D = DESTRO - S = SINISTRO / SPECIFY: D=RIGHT - S=LEFT

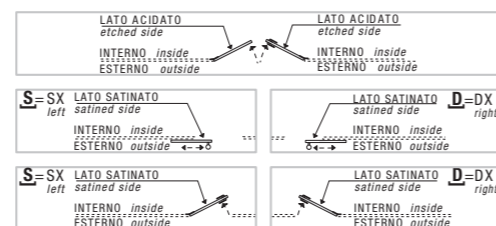

parete divisoria P 100mm

H3 (mm. 2701 ÷ 3096)

PORTE
DOORS **H. 2556 B**

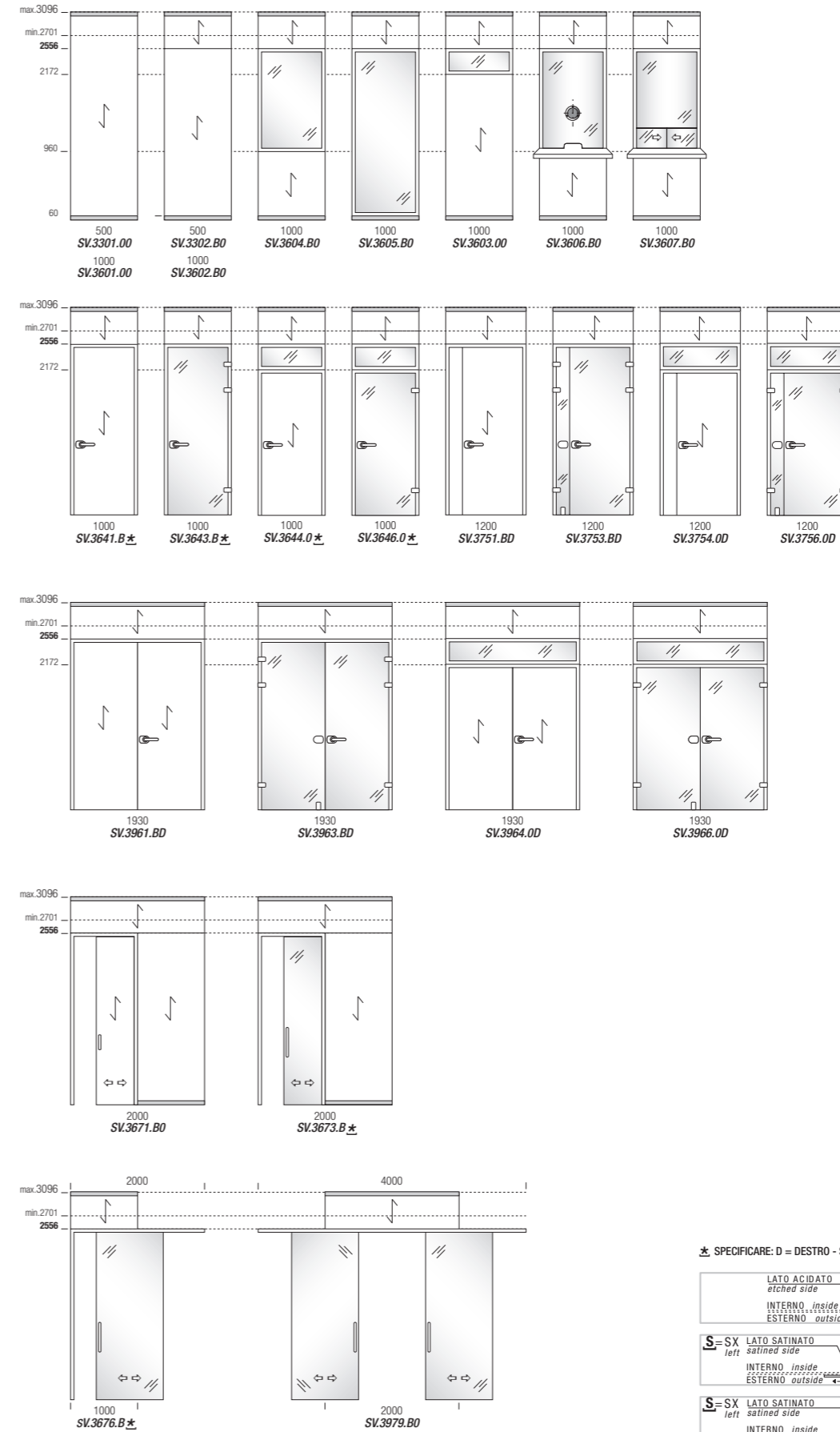

± SPECIFICARE: D = DESTRO - S = SINISTRO / SPECIFY: D=RIGHT - S=LEFT

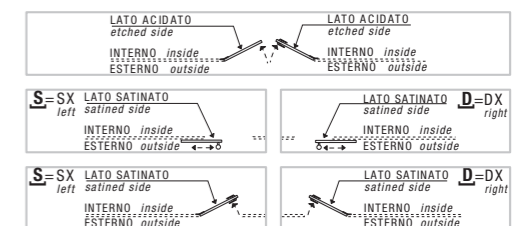

parete divisoria P 100mm

H4 (mm. 3097 ÷ 3480)

PORTE
DOORS **H. 2172 A**

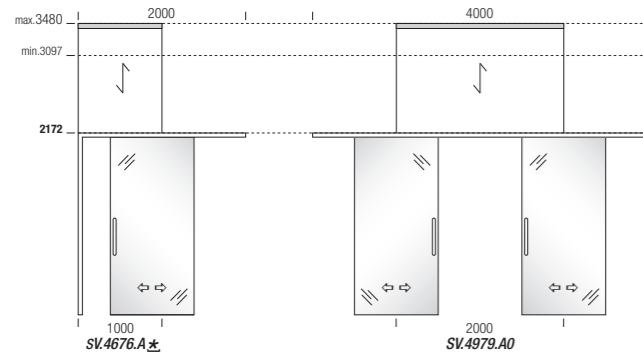
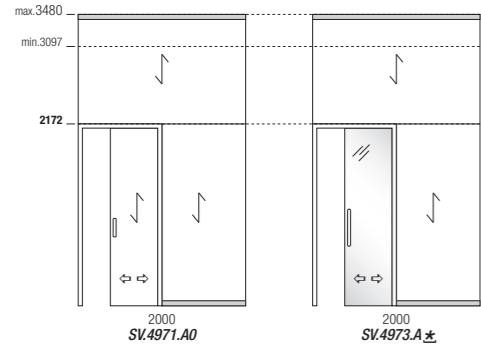
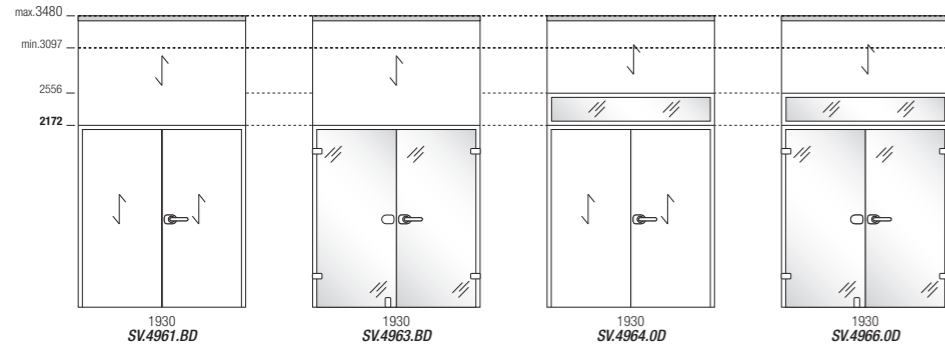
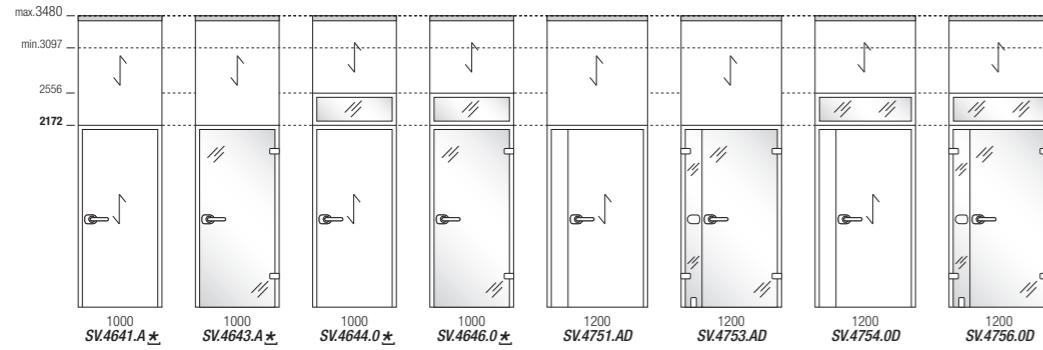
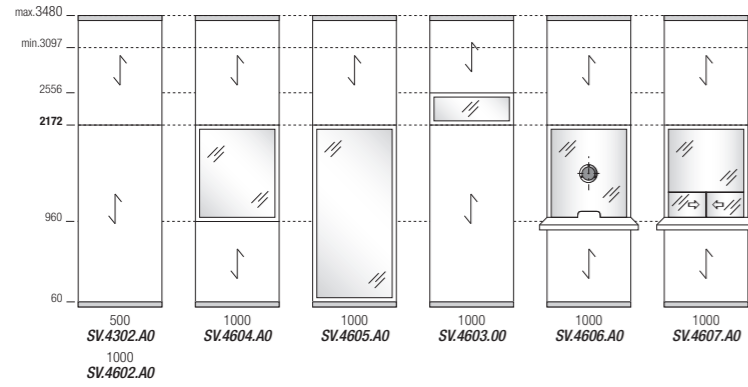

* SPECIFICARE: D = DESTRO - S = SINISTRO / SPECIFY: D=RIGHT - S=LEFT

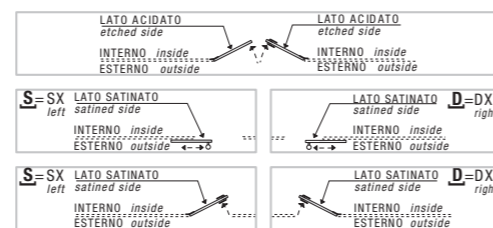

parete divisoria P 100mm

H4 (mm. 3097 ÷ 3480)

PORTE
DOORS **H. 2556 B**

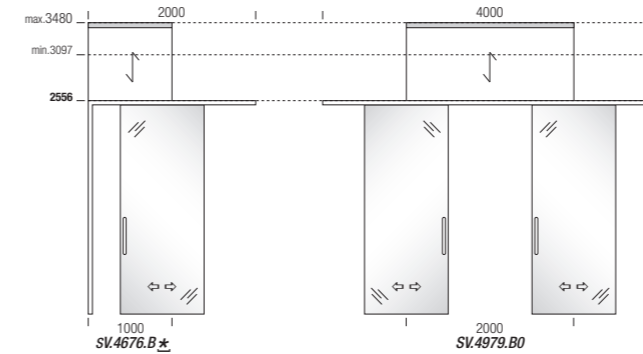
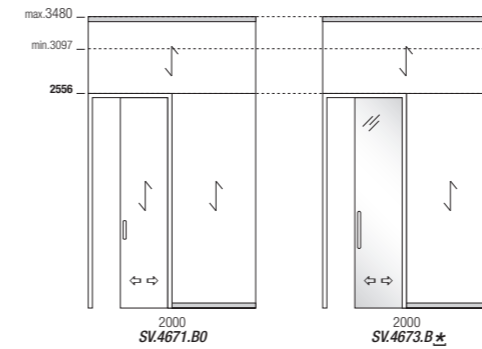
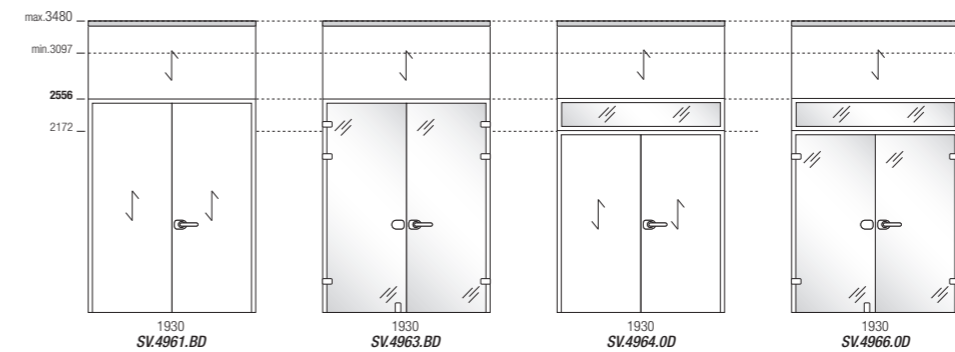
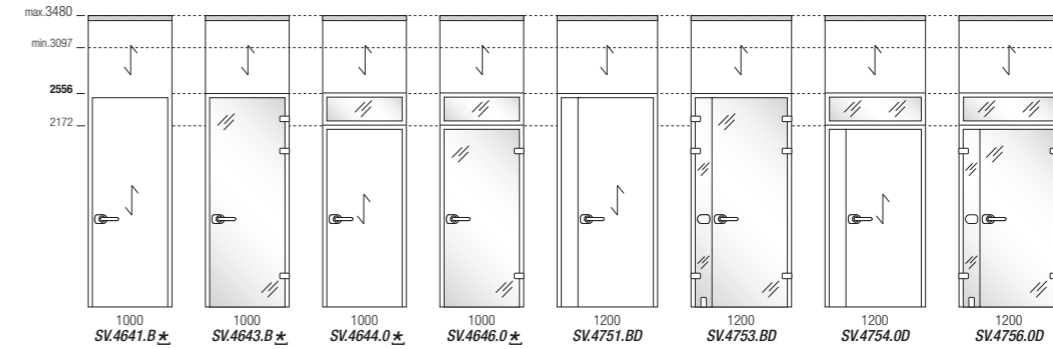
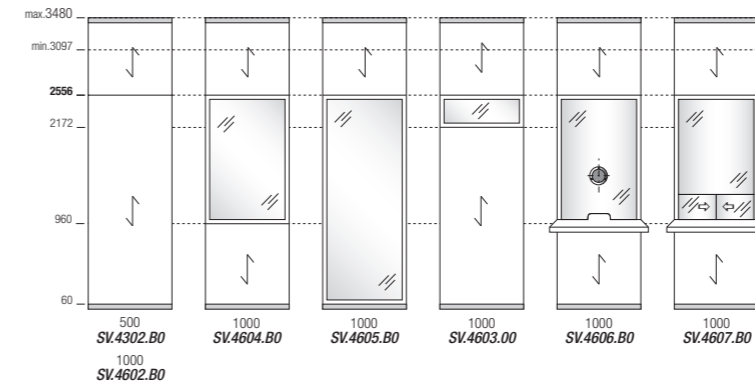

* SPECIFICARE: D = DESTRO - S = SINISTRO / SPECIFY: D=RIGHT - S=LEFT

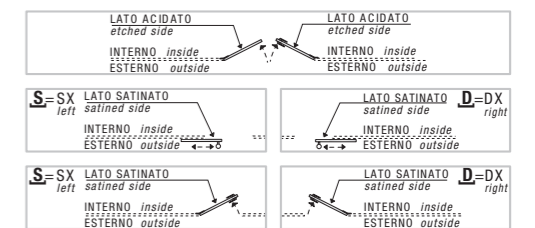

parete attrezzata P 430mm

H0 (mm. 839 + 18 mm top)

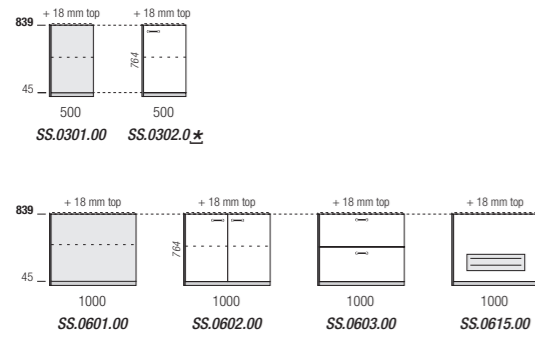

H1 (mm. 2183 + 18 mm top)

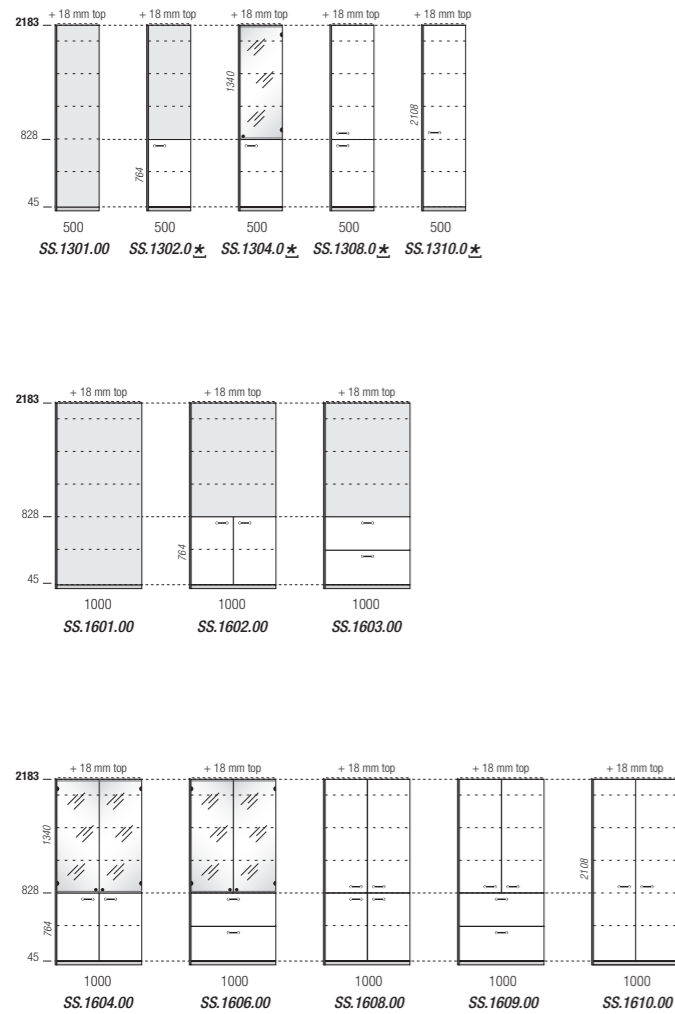

± SPECIFICARE D = DESTRO S = SINISTRO
SPECIFY D=RIGHT S=LEFT

S=SX left D=DX right

parete attrezzata P430mm

H2 (mm. 2360 ÷ 2700)

PORTE DOORS H. 2172 A

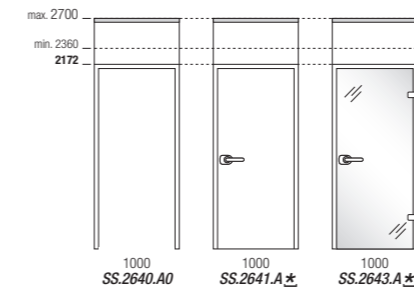
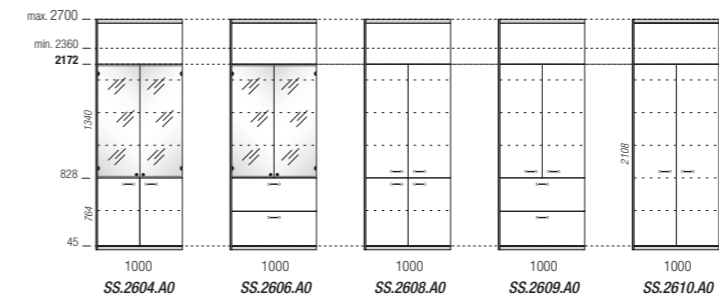
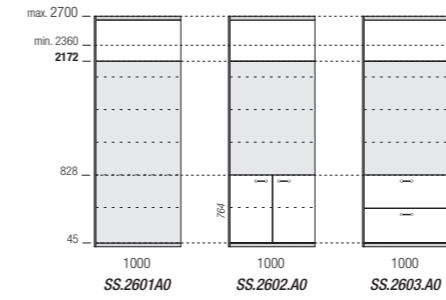
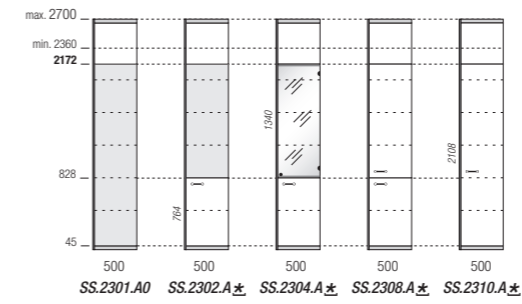

± SPECIFICARE D = DESTRO S = SINISTRO
SPECIFY D=RIGHT S=LEFT

ANTE ARMADIO
CABINET DOORS

S=SX left D=DX right

PORTE DI PASSAGGIO
DOORS OF PASSAGE

S=SX left D=DX right

parete attrezzata P430mm

H3 (mm. 2701 ÷ 3096)

PORTE DOORS H. 2172 **A** H. 2556 **B**

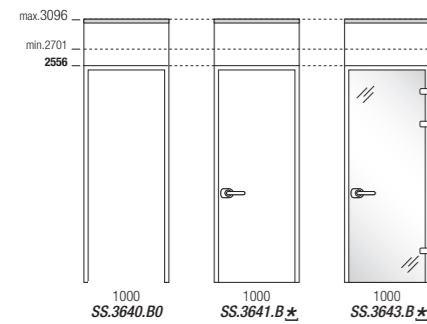
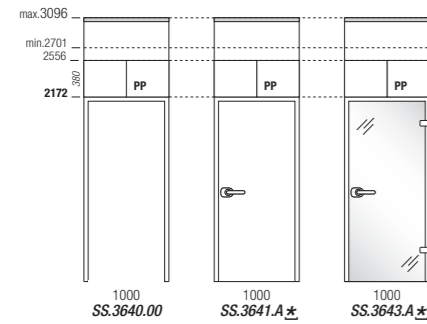
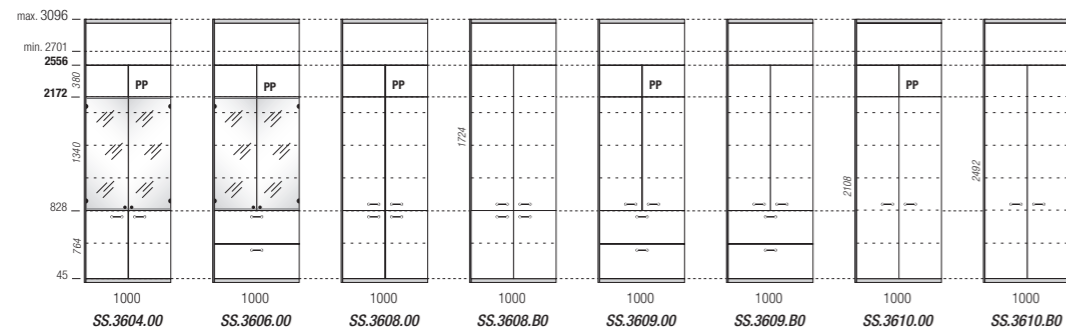
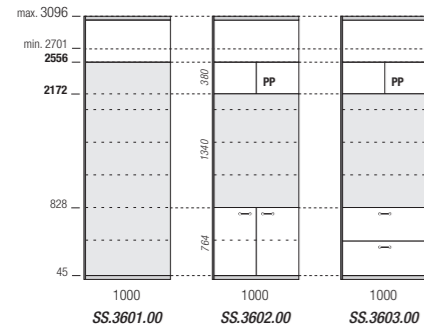
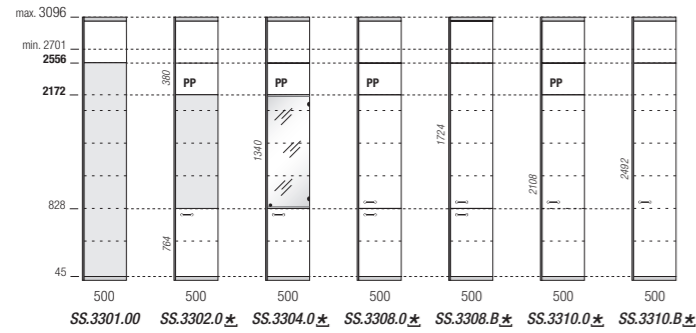

PP = APERTURA PUSH-PULL
PUSH-PULL OPENING
* SPECIFICARE D = DESTRO S = SINISTRO
SPECIFY D=RIGHT S=LEFT

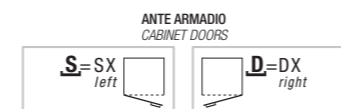

parete attrezzata P430mm

H4 (mm. 3097 ÷ 3480)

PORTE DOORS H. 2172 **A** H. 2556 **B**

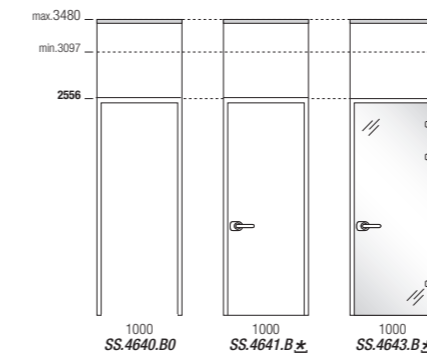
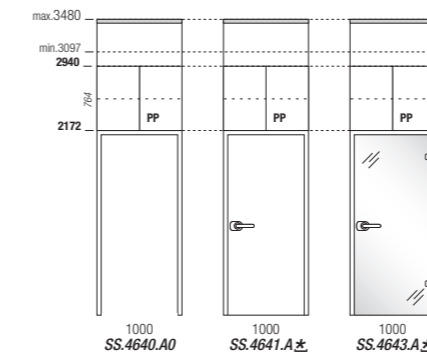
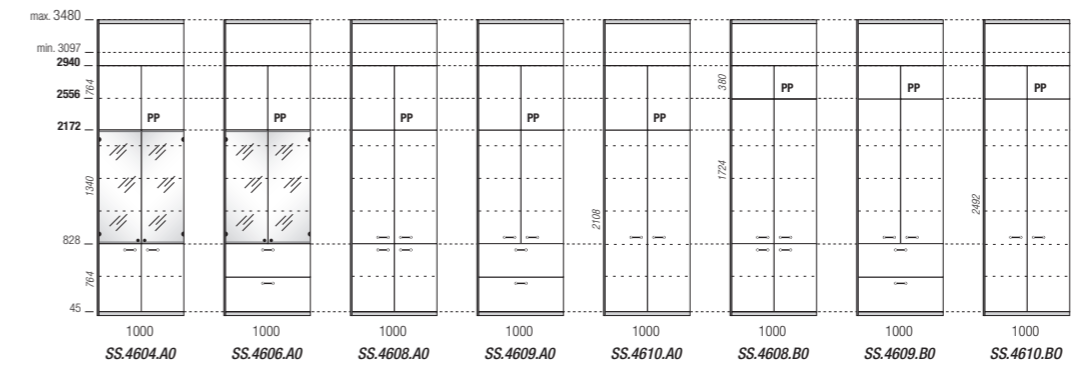
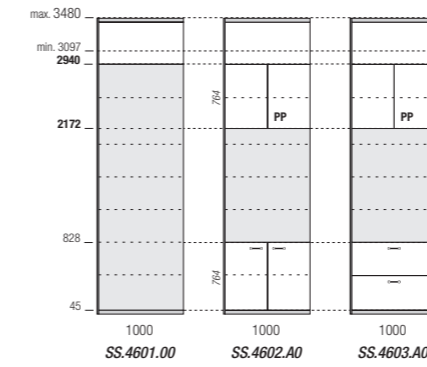
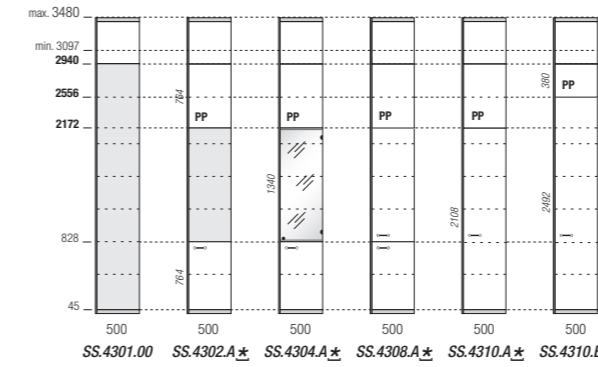

PP = APERTURA PUSH-PULL
PUSH-PULL OPENING
* SPECIFICARE D = DESTRO S = SINISTRO
SPECIFY D=RIGHT S=LEFT



Mat

Materiali e finiture Materials and finishes ! Matériaux et finitions

metallo | metal | metal

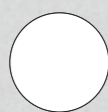

bianco
white
blanc



antracite
anthracite
anthracite



kaffir
kaffir
kaffir



indigo
indigo
indigo

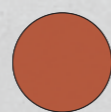

paprika
paprika
paprika

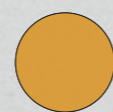

curry
curry
curry

Decorativi

DECORATIVI LEGNO / WOOD / BOIS



113 | **NOCE GRIGIO**



114 | **ROVERE JAZZ**



109 | **OKOBO MINATO**



109 | **ROVERE MARGO**

DECORATIVI COLORE / COLOR / COULEUR



MBI | **BIANCO**

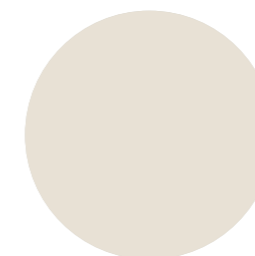

MMP | **MADREPERLA**

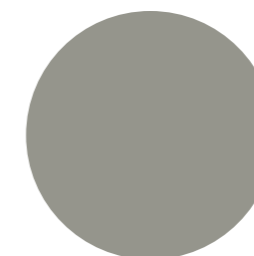

K14 | **SABBIA**

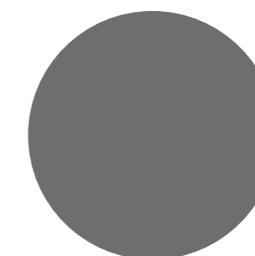

K17 | **GRAFITE**

DECORATIVI GAMMA LACCATA / LACQUERED / LACQUÉE



010 | **CAOLINO**

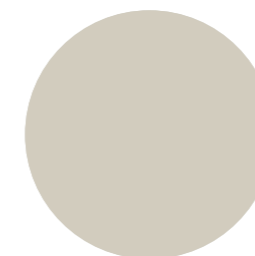

014 | **GOBI**

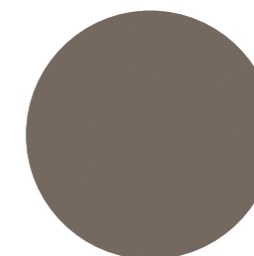

015 | **VISONE**

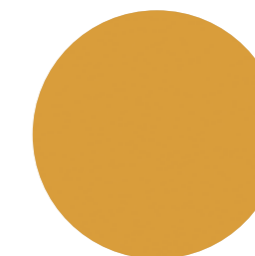

037 | **CURRY**

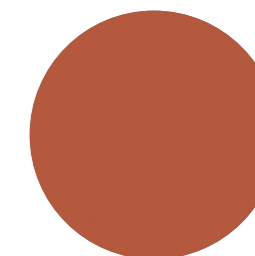

038 | **PAPRIKA**

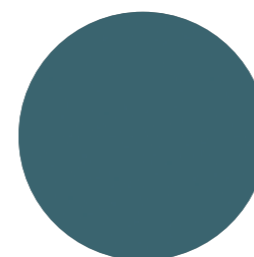

039 | **INDIGO**

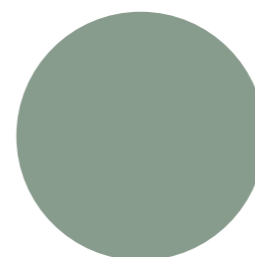

040 | **KAFFIR**

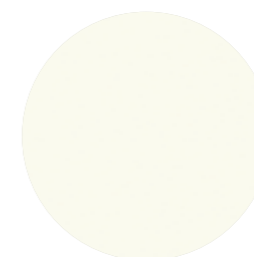

3096 | **BIANCO**

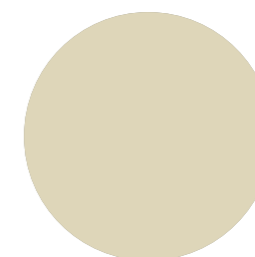

3104 | **CORDA**

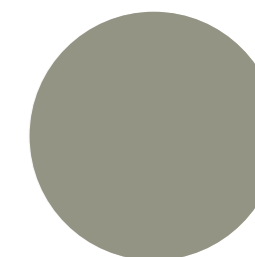

3151 | **TORTORA**

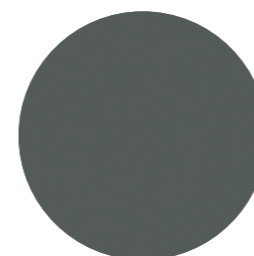

3155 | **ANTRACITE**

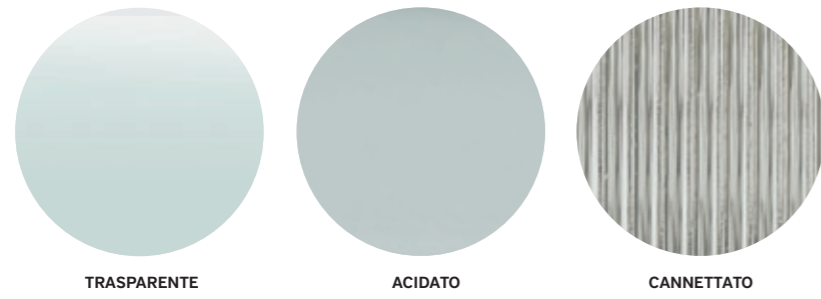

TRASPARENTE

ACIDATO

CANNETTATO

Finiture Vetri Customization glass finishes | Finitions du verre de personnalisation

DISEGNO "A"
SABBIATURA 1 FASCIA
DESIGN "A"
1 SANDING BELT

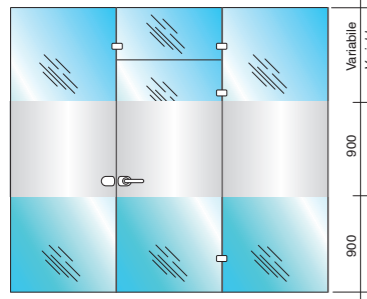

DISEGNO "B"
SABBIATURA 3 FASCE UGUALI
DESIGN "B"
3 EQUAL SANDING BELTS

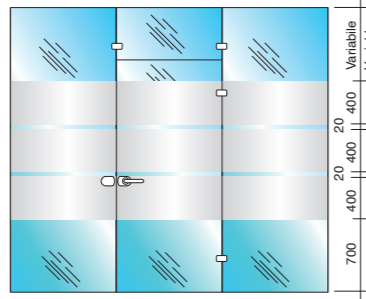

DISEGNO "C"
SABBIATURA A FASCE DIFFERENZIATE
DESIGN "C"
DIFFERENTIATED SANDING BELTS

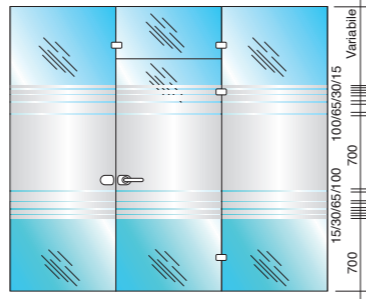

DISEGNO "D"
SABBIATURA A FASCIA QUADRETTATA (90x90 mm.)
DESIGN "D"
SANDING GRIDDED BELTS (90x90 mm.)

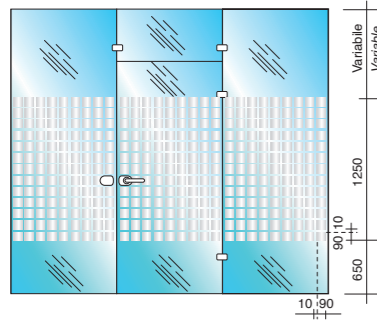

DISEGNO "E"
SABBIATURA A FASCE FINO A TERRA
DESIGN "E"
TILL GROUND SANDING BELTS

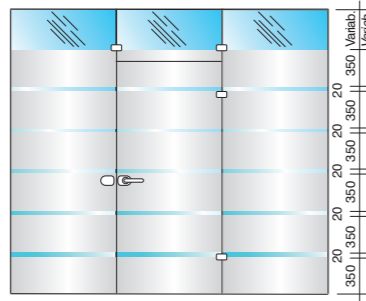

DISEGNO "F"
SABBIATURA A FASCE OMOGENEE ALTERNATE
DESIGN "F"
HOMOGENEOUS SPACED SANDING BELTS

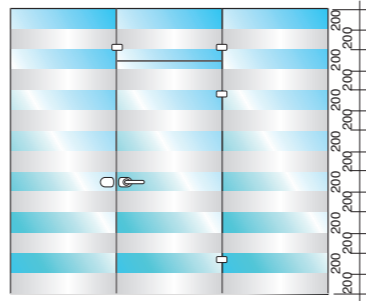

DISEGNO "G"
SABBIATURA A FASCE OMOGENEE STRETTE
DESIGN "G"
HOMOGENEOUS CLOSED SANDING BELTS

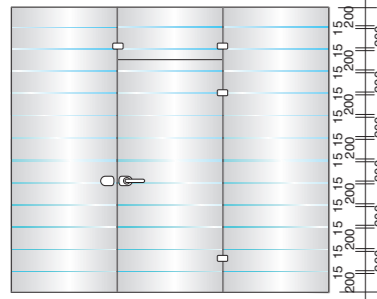

DISEGNO "H"
SABBIATURA A FASCE OMOGENEE LARGHE
DESIGN "H"
HOMOGENEOUS WIDE SANDING BELTS

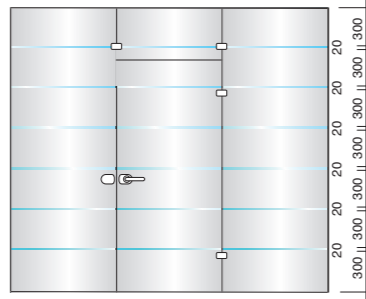

VETRO CON PELLICOLA *
GLASS WITH FILM *

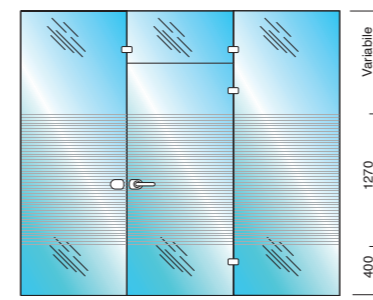

VETRO ACCOPIATO CON TELA METALLICA *
PAIRED GLASS WITH METAL SHEET *



IMMAGINE PERSONALIZZATA *
CUSTOM IMAGES *



LOGHI / SCRITTE *
WRITTEN / LOGOS *



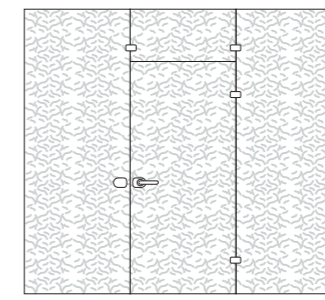
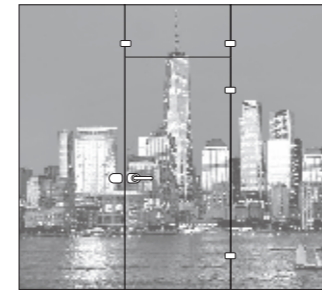
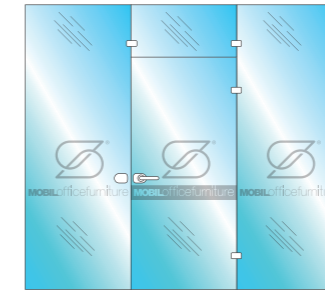
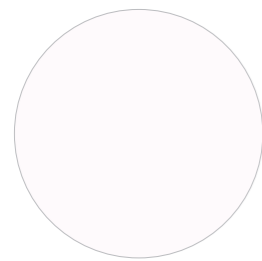

F05 | BIANCO ALASKA

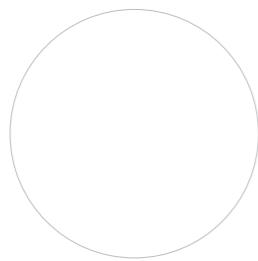

F06 | BIANCO DOVER



F07 | BIANCO KOS



F01 | BIANCO MALÈ

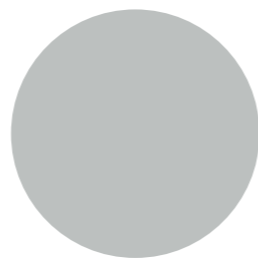

F19 | GRIGIO EFESO

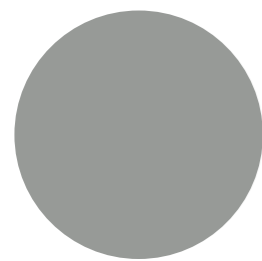

F08 | GRIGIO ANTRIM

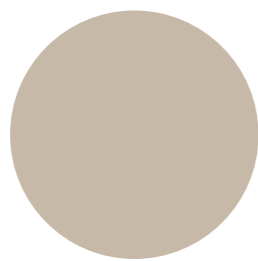

F09 | BEIGE LUXOR

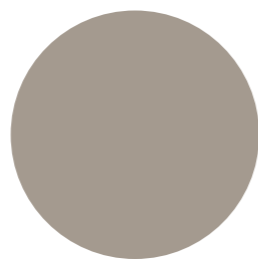

F10 | BEIGE ARIZONA

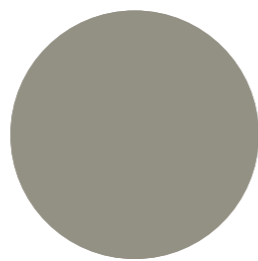

F02 | CASTORO OTTAWA

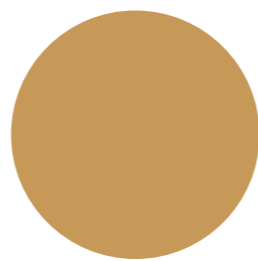

F11 | GIALLO KASHMIR

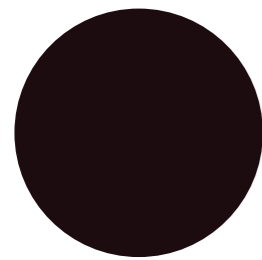

F12 | CACAO ORINOCO

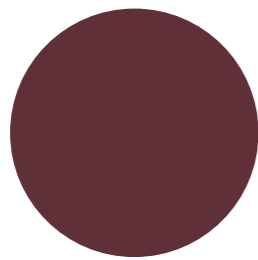

F13 | ROSSO JAIPUR



F14 | ROSSO ASKJA

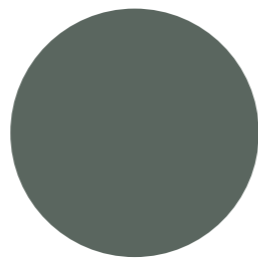

F15 | VERDE COMODORO



F16 | VERDE BRAC

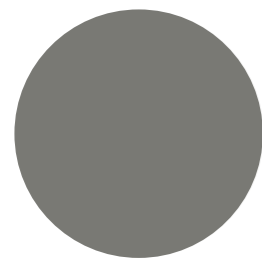

F03 | GRIGIO LONDRA

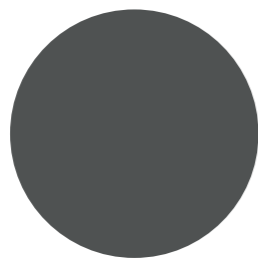

F20 | GRIGIO BROMO

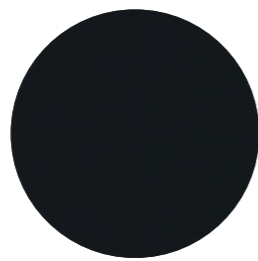

F04 | NERO INGO

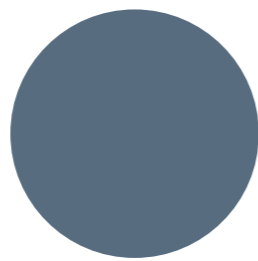

F17 | AZZURRO NAXOS

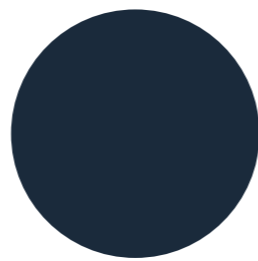

F18 | BLU FES

FENIX NTM® è un materiale innovativo creato per l'interior design, adatto ad applicazioni sia verticali sia orizzontali.

Con una bassa riflessione della luce, la sua superficie è estremamente opaca, anti impronte digitali e piacevolmente soft touch.

Igienico, idoneo al contatto con gli alimenti, facile da pulire, antimuffa e idrorepellente: ecco le caratteristiche che lo rendono particolarmente adatto all'ambiente cucina.

FENIX NTM® is an innovative material created for interior design and suitable for both vertical and horizontal applications.

With low light reflectivity, the surface is extremely opaque, anti-fingerprint and pleasantly soft to the touch.

Hygienic, suitable for contact with food, easy to clean, anti-mould and water-repellent: these are the characteristics that make it particularly suitable for the kitchen environment.

FENIX NTM® est un matériau innovant créé pour la décoration intérieure, adapté aux applications verticales et horizontales.

Avec sa faible réflexion lumineuse, sa surface est extrêmement opaque, anti-traces de doigts et est agréablement douce au toucher.

Hygiénique, adapté au contact avec les aliments, facile à nettoyer, anti-moisissure et hydrofuge: ces caractéristiques rendent ce matériau particulièrement adapté à l'environnement de la cuisine.

Mobil Office Furniture si riserva la facoltà di apportare al prodotto eventuali modifiche tecniche, dimensionali ed estetiche in qualsiasi momento senza preavviso.

Mobil Office Furniture reserves the right to make any changes to the product technical, dimensional and aesthetic at any time without notice.

Mobil Office Furniture se réserve le droit d'apporter au produit toute modification technique, dimensionnelle et esthétique, à tout moment et sans préavis.

A.D., graphic design, images: www.performaitalia.it

Colour separation: ImageVR

Print: Sincromia

MOBIofficefurniture

Via Tittoni, 1 - 31020 Vidor (TV) - ITALY
Tel. +39 0423 988990 - Fax. + 39 0423 988870
mobilofficefurniture.it - info@mobilofficefurniture.it



think office

info@mobilofficefurniture.it



issuu